

bezpečnostní kování

pantry

vložky a klíče

systemy s generálním klíčem

bezpečnostní vložky

pantry

vložky a klíče

objektová kování

klíče

paniková kování

klíčky na okna

madla na dveře

kování na úzké profily

kličky na dveře

kličky na dveře



klíčky na okna

kování na sklo

madla na dveře

klíčky na okna

vložky a klíče

bezpečnostní vložky

vložky a klíče

vložky a klíče



paniková kování

vložky

objektová kování

madla na dveře

bezpečnostní vložky

kování na sklo

systemy s generálním klíčem

kování na úzké profily

bezpečnostní vložky

klíčky na dveře

vložky

bezpečnostní kování

paniková kování

pantry

klíče

bezpečnostní kování

kování na sklo

kličky na dveře

kování na úzké profily

vložky a klíče

Vážení zákazníci,

Díky Vaší přízni Vám přinášíme nové vydání katalogu, kde shrnujeme to nejdůležitější z našeho sortimentu. Důvěra ke značkovým evropským výrobcům je nejen věcí hrdosti ale i dlouhodobé strategie naší společnosti, abychom tak napomohli ke zvyšování kvality života v Česku a na Slovensku. Precizní design je naší srdcovou záležitostí, a proto naše kroky při výběru dodavatele automaticky směřují za lidmi, kteří vyznávají stejné hodnoty jako naši zákazníci. Během let stále více dbáme na charakter výrobního programu každého z nich a osvojujeme si výhody výrobků z pohledu koncového uživatele, abychom našli tu nejlepší možnou alternativu pro ty, kteří chtějí svoje zdroje využít efektivně a s vyšší přidanou hodnotou.

Typy otvorů a měření rozteče kování



BB - dózický otvor (obyčejný klíč)

PZ - cylindrický otvor (vločka - fabka)

WC - otvor na WC západku

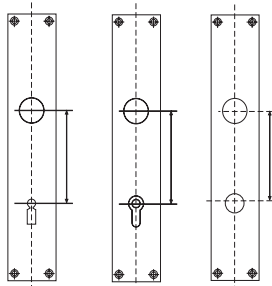

Měření vložek

Jak zjistit rozměry vložky najdete na obrázku. K tloušťce dveří nezapomeňte připočítat tloušťku kování. Vložka by neměla přesahovat kování na vnější straně o více jak 3 mm.

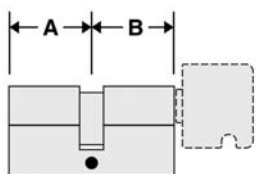

Obchodní podmínky

Všeobecné obchodní podmínky jsou zveřejněné na www.ap-metalia.cz. Věnujte jim pozornost ještě před nákupem. Některá důležitá upozornění uvádíme níže.

Výrobky zhotovené na míru

Velká část zboží je zhotovená na míru podle specifikace zadaných při objednávce (rozměry cylindrických vložek, typy a počty klíčů, typy otvorů a rozteče kování, množství aj). Tato specifikace nesmí být předmětem reklamací ani důvodem na vrácení, či výměnu výrobku.

Klíky na dveře a jejich použití

Klíky jsou určeny pro otevírání a zavírání dveří či oken přenášením rotačního pohybu ke dveřnímu zámku nebo okennímu mechanismu. Kování namontujte podle přiloženého návodu na montáž tak, aby nevzniklo pnutí mezi jednotlivými částmi.

Kování není určeno:

- na vyšší mechanické zatížení než je při běžném zatížení rukou
- na zdolávání překážky vytvořené podložním předmětu pod kliku z druhé strany
- na překonání jiného druhu zablokování

Obrázky výrobků v katalogu jsou ilustrativní.

Údržba

Při čištění od prachu a jiných nečistot používejte výhradně měkkou vlněnou, případně mírně navlhčenou, utěrku. Při ošetřování povrchu se vyhněte kontaktu s chemickými čisticími prostředky (práškové, tekuté čisticí prostředky, rozpouštědla, ředidla, brusné a leštící pasty apod.). Jedině tak vám bude výrobek sloužit k plné spokojenosti. Při použití v agresivním nebo vlhkém prostředí žádejte speciální kování. Doba životnosti závisí na prostředí, frekvenci a způsobu používání, stejně tak i na údržbě.

Záruční podmínky

Výrobce poskytuje za níže uvedených podmínek záruku na odolnost materiálu a všechny vady prokazatelně způsobené v procesu výroby. Na kliky všeobecně poskytujeme záruku 2 roky (piktogramem označené kliky – rozšířená záruka 10 let) od data prodeje, který je vyznačen na pokladním dokladu, v případě, že interiérové kliky:

- byly správně namontované v souladu s návodem na montáž
- byly používány v interiéru (ne ve vlhkém, agresivním a znečištěném prostředí)
- byly používány mimo místa se zvýšenou frekvencí pohybu lidí
- jsou v původním stavu a nebyly na nich vykonané změny nebo opravy uživatelem či třetí osobou
- jsou bez zásahu, který by měl za následek změnu konstrukce, chodu a funkčnosti kování
- nejsou zlomené po nepřiměřeném mechanickém namáhání
- nebyly vybavené jinými přídatnými zařízeními (jiné druhy rozet, čtyřhrany, červíky)
- nebyly mechanicky poškozené ostrými předměty a nástroji
- byly správně udržované bez použití jakýchkoliv čisticích prostředků a detergentů (práškové, tekuté čisticí prostředky, rozpouštědla, ředidla, brusné a leštící pasty apod.)

Při kontaktu s klíčem nebo podobnými kovovými předměty může dojít ke zvýšenému opotřebení.

Doprava

Expedici zboží v rámci České republiky zabezpečuje externí přepravná společnost. Při objednávkách v hodnotě do 2 500 Kč bez DPH bude k ceně zboží připočítané poštovné a balné ve výši 125,- Kč bez DPH. Při objednávkách v hodnotě **vyšší jak 2 500,- Kč bez DPH je poštovné a balné zdarma**. Poštovné a balné pantů je potřeba ověřit. Zboží bývá doručeno zpravidla do 1 pracovního dne od odeslání. Čas doručení je možné si ověřit u přepravce.

Zboží zaslané zpět

Reklamovaný výrobek zašlete zpět pouze po předběžné dohodě. Při zpětném zasílání zboží výrobek důkladně zabalte, aby nedošlo k jeho dalšímu poškození. Zásilky na dobírku nevyzvedáváme. Náklady na dopravu nejsou předmětem reklamace.

Ceny

Ceny v katalogu jsou platné od **8.7.2013**. Z důvodu nestability cen vstupních materiálů si vyhrazujeme právo na úpravu cen. Všechny aktuální ceny najdete na našich internetových stránkách.

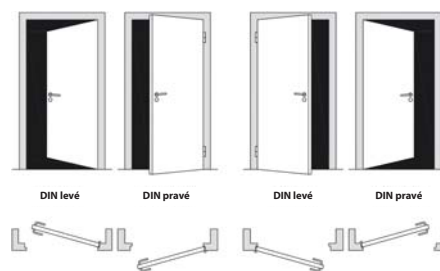

Povrchová úprava:

| | |
|-------------------------------------|------------------------|
| M0 - mosaz bílá | M51 - chrom perla |
| M1 - mosaz zlatá leštěná | M69 - antik stříbrný |
| M2 - mosaz zlatá matná | M75 - antik zlatohnědý |
| M3 - mosaz bronzovaná | F1 - hliník stříbrný |
| MC3 - mosaz bronzovaná česaná | F2 - hliník champagne |
| M4 - chrom leštěný | F3 - hliník zlatý |
| M7 - nikl leštěný | F4 - hliník bronzový |
| M9 - nikl matný | F5 - hliník hnědý |
| M15 - nerez (ušlechtilá ocel matná) | F6 - hliník černý |
| M18 - chrom broušený | F9 - hliník nerezový |
| M50 - chrom matný | F12 - hliník bílý |

| | | | | | |
|-------------------------------|---------|----------------------------------|---------|-----------------------|---------|
| INTERIÉROVÉ KLIKY | str. 4 | MADLA NA DVEŘE | str. 32 | KOVÁNÍ NA SKLO | str. 40 |
| OKENNÍ KLIČKY | str. 24 | SYSTÉMY GENERÁLNÍHO KLÍČE | str. 33 | PANTY | str. 41 |
| BEZPEČNOSTNÍ KOVÁNÍ | str. 26 | BEZPEČNOSTNÍ VLOŽKY | str. 34 | PŘÍSLUŠENSTVÍ | str. 42 |
| KOVÁNÍ NA ÚZKÉ PROFILY | str. 30 | PANIKOVÁ KOVÁNÍ | str. 38 | | |

OBJEKTOVÉ KLIKY

| | | |
|------------------------------------------------------------------------------------|---------|--------|
|  | BAUHAUS | str. 4 |
|  | CECIL | str. 4 |
|  | FABIO | str. 4 |
|  | LEONA | str. 4 |
|  | LIDO K | str. 5 |
|  | TAVIRA | str. 4 |
|  | TESSA D | str. 5 |
|  | TIPO K | str. 5 |
|  | TIPO OK | str. 5 |
|  | UNO K | str. 5 |
|  | UNO OK | str. 5 |

KLIKY NA KULATÉ ROZETĚ

| | | |
|------------------------------------------------------------------------------------|-----------|---------|
|  | ALTEA | str. 11 |
|  | ANTINEA | str. 11 |
|  | AQUILA | str. 9 |
|  | ASTRA | str. 11 |
|  | BEETHOVEN | str. 11 |
|  | CAPELLINO | str. 10 |
|  | CATANIA | str. 6 |
|  | EMERALD | str. 6 |
|  | FIONA | str. 6 |
|  | GAIA | str. 11 |
|  | IBIZA | str. 10 |
|  | IRIS | str. 8 |
|  | JOEL | str. 7 |
|  | KLOTHO 2 | str. 8 |
|  | LAVINIA | str. 8 |
|  | LISA | str. 6 |
|  | MARCO | str. 9 |

| | | |
|-------------------------------------------------------------------------------------|------------|---------|
|  | MATTEO | str. 9 |
|  | MIRA | str. 7 |
|  | MUSA | str. 8 |
|  | OMEGA | str. 10 |
|  | PALLAS | str. 8 |
|  | SIMONA | str. 10 |
|  | TINO | str. 6 |
|  | TREND | str. 7 |
|  | TREND K | str. 7 |
|  | VERENA | str. 6 |
|  | VIVIEN | str. 7 |
|  | WING R M15 | str. 6 |
|  | WING R M18 | str. 7 |
|  | WING R MC3 | str. 11 |

KLIKY NA HRANATÉ ROZETĚ

| | | |
|-------------------------------------------------------------------------------------|---------|---------|
|  | CATANIA | str. 13 |
|  | DEEP | str. 15 |
|  | FOCUS | str. 13 |
|  | CHI | str. 15 |
|  | KALISTA | str. 12 |
|  | KUBE | str. 12 |
|  | LISA | str. 13 |
|  | LUBI | str. 14 |
|  | METRO | str. 13 |
|  | MIRA | str. 14 |
|  | OTIS | str. 13 |
|  | OTTO | str. 15 |
|  | PURE | str. 12 |
|  | QUATTRO | str. 14 |
|  | S-CUBE | str. 15 |

| | | |
|-------------------------------------------------------------------------------------|--------|---------|
|  | SEA | str. 15 |
|  | SIRENA | str. 12 |
|  | SMART | str. 14 |
|  | S-NANU | str. 15 |
|  | SUI | str. 15 |
|  | TANGO | str. 14 |
|  | TECNO | str. 14 |
|  | TINO | str. 13 |
|  | TIPO | str. 13 |
|  | TIRZA | str. 12 |
|  | VERSA | str. 12 |
|  | VIVIEN | str. 14 |
|  | VOGUE | str. 13 |
|  | WING | str. 13 |

KLIKY NA ŠTÍTU

| | | |
|-------------------------------------------------------------------------------------|-----------|---------|
|  | ALTEA | str. 19 |
|  | AMANDA | str. 18 |
|  | ANITA | str. 17 |
|  | ANTINEA | str. 18 |
|  | ASTRAL | str. 18 |
|  | BEETHOVEN | str. 19 |
|  | BEVERLY | str. 17 |
|  | CAPELLO | str. 17 |
|  | DODO | str. 16 |
|  | IBIZA | str. 17 |
|  | LIDO | str. 16 |
|  | MARCO | str. 18 |
|  | MATTEO | str. 18 |
|  | SOIANO | str. 16 |
|  | SUNNY | str. 19 |

| | | |
|-------------------------------------------------------------------------------------|------|---------|
|  | TIPO | str. 16 |
|  | UNO | str. 16 |
|  | WIEN | str. 19 |

RUSTIKÁLNÍ KLIKY

| | | |
|-------------------------------------------------------------------------------------|----------|---------|
|  | AREZIA | str. 20 |
|  | CARLO | str. 20 |
|  | ENRICO | str. 20 |
|  | FEDERICO | str. 20 |
|  | ROMA | str. 20 |
|  | TOLOSA | str. 20 |

HLINÍKOVÉ KLIKY

| | | |
|---------------------------------------------------------------------------------------|-----------|---------|
|  | EMA | str. 23 |
|  | EMA R | str. 22 |
|  | EMA S | str. 22 |
|  | EMERALD | str. 23 |
|  | EMERALD R | str. 22 |
|  | GOLF R | str. 21 |
|  | LUCY | str. 22 |
|  | LUCY R | str. 21 |
|  | LUX | str. 23 |
|  | LUX I | str. 22 |
|  | LUX R | str. 21 |
|  | LUX X | str. 22 |
|  | MODERN | str. 23 |
|  | MODERN R | str. 21 |
|  | OMEGA | str. 23 |
|  | OMEGA R | str. 21 |
|  | REA R | str. 21 |
|  | VERENA | str. 23 |
|  | VERENA R | str. 21 |

TAVIRA R M15



**Interiérové kování
na kovové rozetě s pružinou**
Antikorozní ocel AISI 304, matná
certifikace 3. třídy použití
testováno na 200 000 cyklů

Kč Kč s DPH



| | | | |
|-----|--|-------|-------|
| BB | | 732 | 886 |
| PZ | | 732 | 886 |
| WC | | 1 220 | 1 476 |
| G/K | | 1 220 | 1 476 |



antikorozní ocel
AISI 304



třída použití 3
200 000 cyklů



záruka 10 let



protipožární
certifikát

CECIL R M15



Kč Kč s DPH

| | | |
|-----|-------|-------|
| BB | 718 | 869 |
| PZ | 718 | 869 |
| WC | 1 205 | 1 458 |
| G/K | 1 205 | 1 458 |

LEONA R M15



Kč Kč s DPH

| | | |
|-----|-------|-------|
| BB | 718 | 869 |
| PZ | 718 | 869 |
| WC | 1 205 | 1 458 |
| G/K | 1 205 | 1 458 |

FABIO R M15



Kč Kč s DPH

| | | |
|-----|-------|-------|
| BB | 1 091 | 1 320 |
| PZ | 1 091 | 1 320 |
| WC | 1 578 | 1 909 |
| G/K | 1 578 | 1 909 |

BAUHAUS R M15



Kč Kč s DPH

| | | |
|-----|-------|-------|
| BB | 1 005 | 1 216 |
| PZ | 1 005 | 1 216 |
| WC | 1 492 | 1 805 |
| G/K | 1 492 | 1 805 |



třída použití 3
200 000 cyklů

Vhodné do objektů
s **vysokou frekvencí
používání** veřejností
anebo jinými osobami s nízkou
motivací ke starostlivému
zacházení.







TIPO OK M15



kovové nálitky s metrickým závit-
tem a přesahem 15 mm
pevnější montáž
zvýšená odolnost konstrukce

Kč Kč s DPH

| | | | |
|------------|-------------------------------------------------------------------------------------|-----|-----|
| BB |  | 412 | 499 |
| PZ |  | 412 | 499 |
| WC |  | 728 | 881 |
| G/K |  | 780 | 944 |



antikoroziční ocel
AISI 304



všechna nerezová kování jsou vyba-
vená zajišťovacím červíkem, který se
prorazí čtyřhranem a zamezí
pohybu kliky

UNO OK M15



Kč Kč s DPH

| | | |
|------------|-----|-----|
| BB | 412 | 499 |
| PZ | 412 | 499 |
| WC | 728 | 881 |
| G/K | 780 | 944 |



TESSA D M15



Kč Kč s DPH

| | | |
|------------|-----|-------|
| BB | 597 | 722 |
| PZ | 597 | 722 |
| WC | 779 | 943 |
| G/K | 909 | 1 100 |



- » **Jednoduchá montáž** na prošroubování skrz dveře
- » **Kovové svorníky** s metrickým závitem přesahují 15 mm od spodní **kovové konstrukce** a zaručují pevné uchycení
- » Zajišťovací červík hrotem prorazí stěnu čtyřhranem a **znemožní nežádoucí pohyb kliky**

TIPO K M15



Kč Kč s DPH

| | | |
|------------|-----|-----|
| BB | 325 | 393 |
| PZ | 325 | 393 |
| WC | 640 | 774 |
| G/K | 735 | 889 |



UNO K M15



Kč Kč s DPH

| | | |
|------------|-----|-----|
| BB | 325 | 393 |
| PZ | 325 | 393 |
| WC | 640 | 774 |
| G/K | 735 | 889 |



LIDO K M15



Kč Kč s DPH

| | | |
|------------|-----|-----|
| BB | 325 | 393 |
| PZ | 325 | 393 |
| WC | 640 | 774 |
| G/K | 735 | 889 |





FIONA R M15



antikorozní ocel
AISI 304



**Interiérové kování
na trvanlivé plastové (ABS)
podrozetě s integrovanou
pružinou**

Antikorozní ocel AISI 304, matná

Kč Kč s DPH

| | | | |
|------------|--|-------|-------|
| BB | | 723 | 875 |
| PZ | | 723 | 875 |
| WC | | 1 032 | 1 249 |
| G/K | | 1 032 | 1 249 |

CATANIA R M15



Kč Kč s DPH

| | | |
|------------|-----|-----|
| BB | 415 | 502 |
| PZ | 415 | 502 |
| WC | 722 | 874 |
| G/K | 776 | 939 |



LISA R M15



Kč Kč s DPH

| | | |
|------------|-----|-------|
| BB | 596 | 721 |
| PZ | 596 | 721 |
| WC | 911 | 1 102 |
| G/K | 911 | 1 102 |



WING R M15



Kč Kč s DPH

| | | |
|------------|-----|-------|
| BB | 616 | 745 |
| PZ | 616 | 745 |
| WC | 932 | 1 128 |
| G/K | 932 | 1 128 |



TINO R M15



Kč Kč s DPH

| | | |
|------------|-----|-----|
| BB | 407 | 492 |
| PZ | 407 | 492 |
| WC | 722 | 874 |
| G/K | 776 | 939 |



EMERALD M9



Kč Kč s DPH

| | | |
|------------|-------|-------|
| BB | 737 | 892 |
| PZ | 737 | 892 |
| WC | 1 080 | 1 307 |
| G/K | 1 288 | 1 558 |

VERENA R M15



Kč Kč s DPH

| | | |
|------------|-----|-------|
| BB | 545 | 659 |
| PZ | 545 | 659 |
| WC | 861 | 1 042 |
| G/K | 861 | 1 042 |





TREND R M4/M9



Kč Kč s DPH

| | | |
|------------|-------|-------|
| BB | 860 | 1 041 |
| PZ | 860 | 1 041 |
| WC | 1 117 | 1 352 |
| G/K | 1 247 | 1 509 |

MIRA R M4/M15



Kč Kč s DPH

| | | |
|------------|-----|-------|
| BB | 597 | 722 |
| PZ | 597 | 722 |
| WC | 805 | 974 |
| G/K | 857 | 1 037 |



VIVIEN R M4/M15



Kč Kč s DPH

| | | |
|------------|-------|-------|
| BB | 909 | 1 100 |
| PZ | 909 | 1 100 |
| WC | 1 169 | 1 414 |
| G/K | 1 169 | 1 414 |



JOEL M4



Kč Kč s DPH

| | | |
|------------|-------|-------|
| BB | 860 | 1 041 |
| PZ | 860 | 1 041 |
| WC | 1 175 | 1 422 |
| G/K | 1 383 | 1 673 |

WING R M18



Kč Kč s DPH

| | | |
|------------|-----|-----|
| BB | 494 | 598 |
| PZ | 494 | 598 |
| WC | 676 | 818 |
| G/K | 766 | 927 |

TREND K M4/M18



Kč Kč s DPH

| | | |
|-----------|-----|-----|
| BB | 597 | 722 |
| PZ | 597 | 722 |



KLOTHO 2

M7/M9

Kč Kč s DPH

| | | | |
|-----|--|-------|-------|
| BB | | 1 170 | 1 416 |
| PZ | | 1 170 | 1 416 |
| WC | | 1 508 | 1 825 |
| G/K | | 1 638 | 1 982 |



M4/M18



M1/M2

PALLAS



M7/M9



M1/M2



PVD povrch
více na str. 12

Kč Kč s DPH

| | | |
|-----|-------|-------|
| BB | 2 053 | 2 484 |
| PZ | 2 053 | 2 484 |
| WC | 2 569 | 3 108 |
| G/K | 2 736 | 3 311 |

PALLAS



M50/M4



M9/M4

Kč Kč s DPH

| | | |
|-----|-------|-------|
| BB | 1 534 | 1 856 |
| PZ | 1 534 | 1 856 |
| WC | 1 872 | 2 265 |
| G/K | 1 872 | 2 265 |

IRIS



M9



M1



PVD povrch
více na str. 12

Kč Kč s DPH

| | | |
|-----|-------|-------|
| BB | 1 755 | 2 124 |
| PZ | 1 755 | 2 124 |
| WC | 2 257 | 2 731 |
| G/K | 2 439 | 2 951 |

LAVINIA



M9/M4



M50/M4

Kč Kč s DPH

| | | |
|-----|-------|-------|
| BB | 1 482 | 1 793 |
| PZ | 1 482 | 1 793 |
| WC | 1 794 | 2 171 |
| G/K | 1 794 | 2 171 |

MUSA R



M9



M4

Kč Kč s DPH

| | | |
|----|-------|-------|
| BB | 1 118 | 1 353 |
| PZ | 1 118 | 1 353 |
| WC | 1 378 | 1 667 |



MARCO R



M7/M9



M4/M18



M1/M2

Kč Kč s DPH

| | | | |
|----|-------------------------------------------------------------------------------------------------------------------------------------------------------------------------|-----|-------|
| BB |  | 779 | 943 |
| PZ |  | 779 | 943 |
| WC |   | 961 | 1 163 |

MATTEO R



M7/M9



M4/M18

| | Kč | Kč s DPH |
|----|-----|----------|
| BB | 675 | 817 |
| PZ | 675 | 817 |
| WC | 852 | 1 031 |

AQUILA R M2



Kč Kč s DPH

| | | |
|-----|-------|-------|
| BB | 831 | 1 006 |
| PZ | 831 | 1 006 |
| WC | 1 013 | 1 226 |
| G/K | 1 013 | 1 226 |

AQUILA R



M9



M18

Kč Kč s DPH

| | | |
|-----|-------|-------|
| BB | 831 | 1 006 |
| PZ | 831 | 1 006 |
| WC | 1 013 | 1 226 |
| G/K | 1 013 | 1 226 |

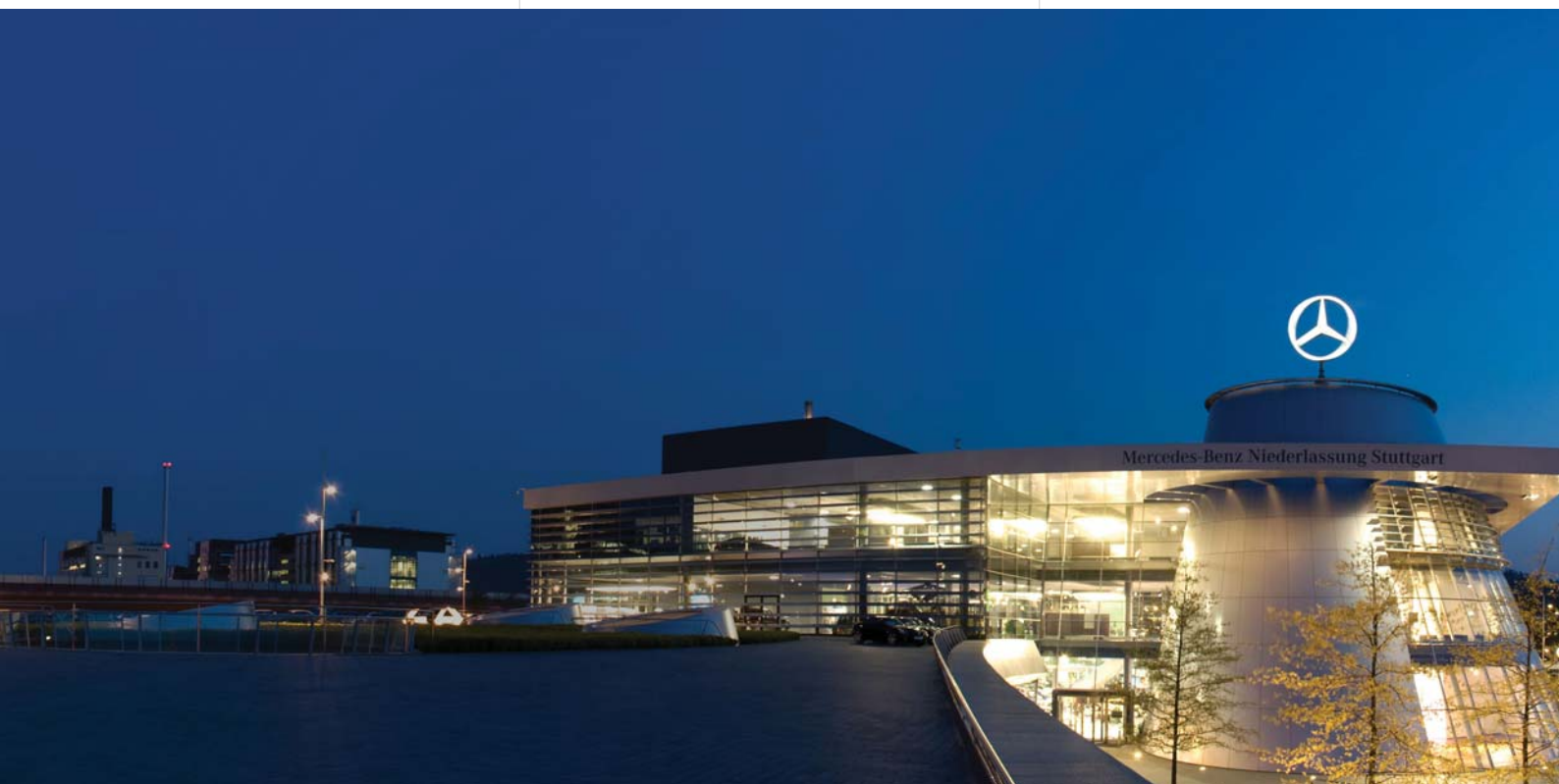

CAPELLINO



M9

| M2, M3 | Kč | Kč s DPH |
|--------|-----|----------|
| BB | 519 | 628 |
| PZ | 519 | 628 |
| WC | 779 | 943 |
| G/K | 779 | 943 |



M2



M3



M4

| M4, M9 | Kč | Kč s DPH |
|--------|-----|----------|
| BB | 675 | 817 |
| PZ | 675 | 817 |
| WC | 935 | 1 131 |
| G/K | 935 | 1 131 |

IBIZA R



M1



M2

| | Kč | Kč s DPH |
|-----|-----|----------|
| BB | 337 | 408 |
| PZ | 337 | 408 |
| WC | 519 | 628 |
| G/K | 519 | 628 |

IBIZA R MC3



| | Kč | Kč s DPH |
|-----|-----|----------|
| BB | 337 | 408 |
| PZ | 337 | 408 |
| WC | 519 | 628 |
| G/K | 519 | 628 |

IBIZA R M9



| | Kč | Kč s DPH |
|-----|-----|----------|
| BB | 337 | 408 |
| PZ | 337 | 408 |
| WC | 519 | 628 |
| G/K | 519 | 628 |

SIMONA R M9



| | Kč | Kč s DPH |
|-----|-----|----------|
| BB | 336 | 407 |
| PZ | 336 | 407 |
| WC | 557 | 674 |
| G/K | 557 | 674 |

SIMONA R



M4



M18

| | Kč | Kč s DPH |
|-----|-----|----------|
| BB | 336 | 407 |
| PZ | 336 | 407 |
| WC | 557 | 674 |
| G/K | 557 | 674 |

OMEGA R M18



| | Kč | Kč s DPH |
|-----|-----|----------|
| BB | 519 | 628 |
| PZ | 519 | 628 |
| WC | 675 | 817 |
| G/K | 675 | 817 |

BEETHOVEN R







M3



M1

Kč Kč s DPH

| | | | |
|-----|-------------------------------------------------------------------------------------|-------|-------|
| BB |  | 961 | 1 163 |
| PZ |  | 961 | 1 163 |
| WC |  | 1 143 | 1 383 |
| G/K |  | 1 143 | 1 383 |

ASTRA R



M3



M1

Kč Kč s DPH

| | | |
|-----|-----|-------|
| BB | 676 | 818 |
| PZ | 676 | 818 |
| WC | 858 | 1 038 |
| G/K | 858 | 1 038 |

GAIA R MC3



Kč Kč s DPH

| | | |
|-----|-----|-----|
| BB | 493 | 597 |
| PZ | 493 | 597 |
| WC | 688 | 832 |
| G/K | 766 | 927 |

WING R MC3



Kč Kč s DPH

| | | |
|-----|-----|-----|
| BB | 532 | 644 |
| PZ | 532 | 644 |
| WC | 714 | 864 |
| G/K | 766 | 927 |

ANTINEA R



M2



M3

Kč Kč s DPH

| | | |
|-----|-----|-------|
| BB | 647 | 783 |
| PZ | 647 | 783 |
| WC | 829 | 1 003 |
| G/K | 829 | 1 003 |

ANTINEA R M4



Kč Kč s DPH

| | | |
|-----|-----|-------|
| BB | 743 | 899 |
| PZ | 743 | 899 |
| WC | 925 | 1 119 |
| G/K | 925 | 1 119 |

ALTEA R M75



Kč Kč s DPH

| | | |
|-----|-------|-------|
| BB | 1 134 | 1 372 |
| PZ | 1 134 | 1 372 |
| WC | 1 394 | 1 687 |
| G/K | 1 394 | 1 687 |



KUBE S M4



ekologická technologie
nanášení povrchové úpravy
výjimečná kvalita
se zárukou 10 let



PVD povrch
záruka 10 let

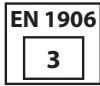

třída použití 3
200 000 cyklů



záruka 10 let

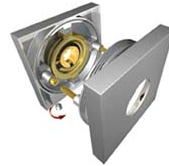

kovová konstrukce
certifikovaná
na 200 000 cyklů

Kč Kč s DPH

| | | | |
|------------|--|-------|-------|
| BB | | 1 716 | 2 076 |
| PZ | | 1 716 | 2 076 |
| WC | | 2 151 | 2 603 |
| G/K | | 2 298 | 2 781 |

KUBE S M9

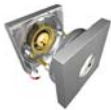

Kč Kč s DPH

| | | |
|------------|-------|-------|
| BB | 1 716 | 2 076 |
| PZ | 1 716 | 2 076 |
| WC | 2 151 | 2 603 |
| G/K | 2 298 | 2 781 |

VERSA S



M9

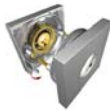

M4/M9



Kč Kč s DPH

| | | |
|------------|-------|-------|
| BB | 2 028 | 2 454 |
| PZ | 2 028 | 2 454 |
| WC | 2 542 | 3 076 |
| G/K | 2 716 | 3 286 |

TIRZA S



M9

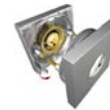

M4/M9



Kč Kč s DPH

| | | |
|------------|-------|-------|
| BB | 2 028 | 2 454 |
| PZ | 2 028 | 2 454 |
| WC | 2 542 | 3 076 |
| G/K | 2 716 | 3 286 |

PURE S M15

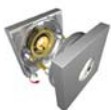

Kč Kč s DPH

| | | |
|------------|-------|-------|
| BB | 1 859 | 2 249 |
| PZ | 1 859 | 2 249 |
| WC | 2 294 | 2 776 |
| G/K | 2 441 | 2 954 |

KALISTA S M15

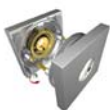

Kč Kč s DPH

| | | |
|------------|-------|-------|
| BB | 1 716 | 2 076 |
| PZ | 1 716 | 2 076 |
| WC | 2 151 | 2 603 |
| G/K | 2 298 | 2 781 |

SIRENA S M15

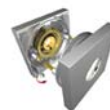

Kč Kč s DPH

| | | |
|------------|-------|-------|
| BB | 1 716 | 2 076 |
| PZ | 1 716 | 2 076 |
| WC | 2 151 | 2 603 |
| G/K | 2 298 | 2 781 |

FOCUS S M15



| | Kč | Kč s DPH |
|------------|-------|----------|
| BB | 1 003 | 1 214 |
| PZ | 1 003 | 1 214 |
| WC | 1 347 | 1 630 |
| G/K | 1 347 | 1 630 |



OTIS S M15



| | Kč | Kč s DPH |
|------------|-------|----------|
| BB | 1 003 | 1 214 |
| PZ | 1 003 | 1 214 |
| WC | 1 347 | 1 630 |
| G/K | 1 347 | 1 630 |



VOGUE S M15



| | Kč | Kč s DPH |
|------------|-------|----------|
| BB | 1 003 | 1 214 |
| PZ | 1 003 | 1 214 |
| WC | 1 347 | 1 630 |
| G/K | 1 347 | 1 630 |



CATANIA S M15



| | Kč | Kč s DPH |
|------------|-------|----------|
| BB | 667 | 807 |
| PZ | 667 | 807 |
| WC | 1 026 | 1 241 |
| G/K | 1 026 | 1 241 |



LISA S M15



| | Kč | Kč s DPH |
|------------|-------|----------|
| BB | 857 | 1 037 |
| PZ | 857 | 1 037 |
| WC | 1 215 | 1 470 |
| G/K | 1 215 | 1 470 |



METRO S M15



| | Kč | Kč s DPH |
|------------|-------|----------|
| BB | 775 | 938 |
| PZ | 775 | 938 |
| WC | 1 134 | 1 372 |
| G/K | 1 134 | 1 372 |



TIPO S M15



| | Kč | Kč s DPH |
|------------|-----|----------|
| BB | 586 | 709 |
| PZ | 586 | 709 |
| WC | 944 | 1 142 |
| G/K | 944 | 1 142 |



TINO S M15



| | Kč | Kč s DPH |
|------------|-------|----------|
| BB | 667 | 807 |
| PZ | 667 | 807 |
| WC | 1 026 | 1 241 |
| G/K | 1 026 | 1 241 |



WING S M15



| | Kč | Kč s DPH |
|------------|-------|----------|
| BB | 877 | 1 061 |
| PZ | 877 | 1 061 |
| WC | 1 235 | 1 494 |
| G/K | 1 235 | 1 494 |





QUATTRO S M9

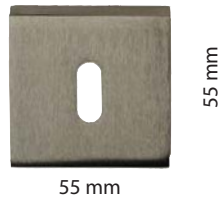

Kč Kč s DPH

| | | | |
|-----------|--|-------|-------|
| BB | | 1 222 | 1 479 |
| PZ | | 1 222 | 1 479 |
| WC | | 1 482 | 1 793 |

TECNO S M18



55 mm

LUBI



M4/nero



M4/M9

VIVIEN S M4/M15



| | Kč | Kč s DPH |
|-----------|-----------|-----------------|
| BB | 1 222 | 1 479 |
| PZ | 1 222 | 1 479 |
| WC | 1 482 | 1 793 |

| | Kč | Kč s DPH |
|------------|-----------|-----------------|
| BB | 1 003 | 1 214 |
| PZ | 1 003 | 1 214 |
| WC | 1 319 | 1 596 |
| G/K | 1 553 | 1 879 |



| | Kč | Kč s DPH |
|------------|-----------|-----------------|
| BB | 1 039 | 1 257 |
| PZ | 1 039 | 1 257 |
| WC | 1 299 | 1 572 |
| G/K | 1 299 | 1 572 |



SMART



M9



M4/M18

TANGO M9



| | Kč | Kč s DPH |
|-----------|-----------|-----------------|
| BB | 648 | 784 |
| PZ | 648 | 784 |
| WC | 882 | 1 067 |

| | Kč | Kč s DPH |
|-----------|-----------|-----------------|
| BB | 617 | 747 |
| PZ | 617 | 747 |
| WC | 851 | 1 030 |

MIRA S M4/M15



| | Kč | Kč s DPH |
|------------|-----------|-----------------|
| BB | 779 | 943 |
| PZ | 779 | 943 |
| WC | 1 013 | 1 226 |
| G/K | 1 013 | 1 226 |



CHI

M9



M50

Kč Kč s DPH

| | | | |
|-----------|--|-------|-------|
| BB | | 1 245 | 1 506 |
| PZ | | 1 245 | 1 506 |
| WC | | 1 464 | 1 771 |

OTTO M9



S-CUBE



M9



M50

SEA



M9



M51

Kč Kč s DPH

| | | |
|-----------|-------|-------|
| BB | 1 557 | 1 884 |
| PZ | 1 557 | 1 884 |

Kč Kč s DPH

| | | |
|-----------|-------|-------|
| BB | 1 245 | 1 506 |
| PZ | 1 245 | 1 506 |
| WC | 1 464 | 1 771 |

Kč Kč s DPH

| | | |
|-----------|-------|-------|
| BB | 1 245 | 1 506 |
| PZ | 1 245 | 1 506 |
| WC | 1 464 | 1 771 |

S-NANU M50



DEEP



M9/černé dřevo

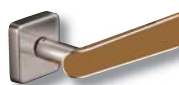

M9/ořech

SUI M9



Kč Kč s DPH

| | | |
|-----------|-------|-------|
| BB | 1 245 | 1 506 |
| PZ | 1 245 | 1 506 |
| WC | 1 464 | 1 771 |

Kč Kč s DPH

| | | |
|-----------|-------|-------|
| BB | 1 557 | 1 884 |
| PZ | 1 557 | 1 884 |

Kč Kč s DPH

| | | |
|-----------|-------|-------|
| BB | 1 245 | 1 506 |
| PZ | 1 245 | 1 506 |
| WC | 1 464 | 1 771 |

TIPO B M15

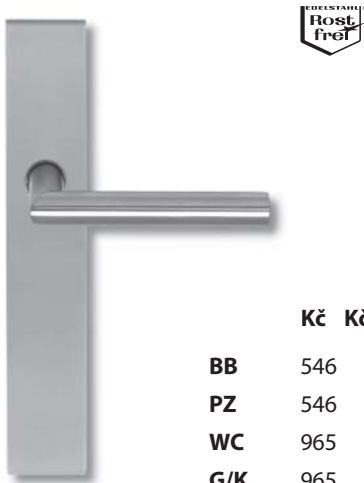

| | Kč | Kč s DPH |
|------------|-----|----------|
| BB | 546 | 661 |
| PZ | 546 | 661 |
| WC | 965 | 1 168 |
| G/K | 965 | 1 168 |

UNO A M15



| | Kč | Kč s DPH |
|------------|-----|----------|
| BB | 528 | 639 |
| PZ | 528 | 639 |
| WC | 947 | 1 146 |
| G/K | 947 | 1 146 |

UNO B M15

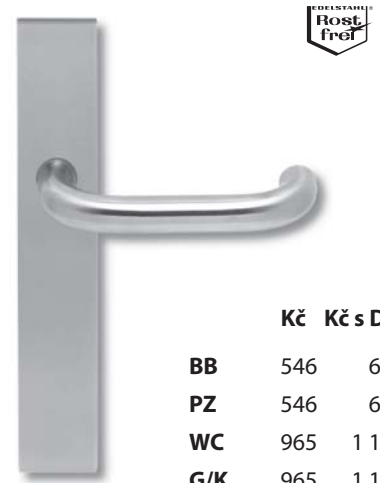

| | Kč | Kč s DPH |
|------------|-----|----------|
| BB | 546 | 661 |
| PZ | 546 | 661 |
| WC | 965 | 1 168 |
| G/K | 965 | 1 168 |

LIDO A M15



| | Kč | Kč s DPH |
|------------|-----|----------|
| BB | 528 | 639 |
| PZ | 528 | 639 |
| WC | 947 | 1 146 |
| G/K | 947 | 1 146 |

DODO M9



| | Kč | Kč s DPH |
|------------|-------|----------|
| BB | 901 | 1 090 |
| PZ | 901 | 1 090 |
| WC | 1 135 | 1 373 |
| G/K | 1 135 | 1 373 |

SOIANO M9



| | Kč | Kč s DPH |
|------------|-------|----------|
| BB | 901 | 1 090 |
| PZ | 901 | 1 090 |
| WC | 1 135 | 1 373 |
| G/K | 1 135 | 1 373 |



IBIZA M9



| | Kč | Kč s DPH |
|------------|-----|----------|
| BB | 467 | 565 |
| PZ | 467 | 565 |
| WC | 675 | 817 |
| G/K | 675 | 817 |

IBIZA MC3



| | Kč | Kč s DPH |
|------------|-----|----------|
| BB | 379 | 459 |
| PZ | 379 | 459 |
| WC | 571 | 691 |
| G/K | 571 | 691 |

IBIZA

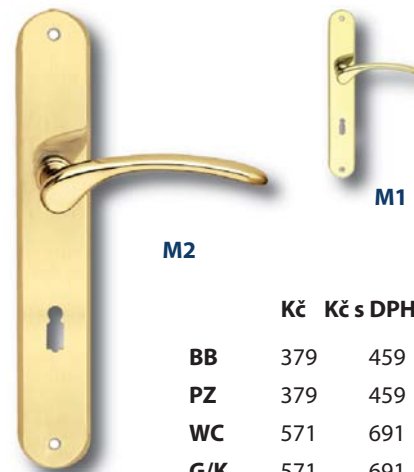

M2

M1

| | Kč | Kč s DPH |
|------------|-----|----------|
| BB | 379 | 459 |
| PZ | 379 | 459 |
| WC | 571 | 691 |
| G/K | 571 | 691 |

CAPELLO

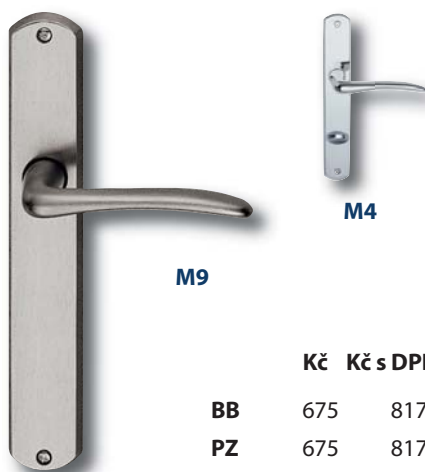

M9

M4

| | Kč | Kč s DPH |
|------------|-----|----------|
| BB | 675 | 817 |
| PZ | 675 | 817 |
| WC | 935 | 1 131 |
| G/K | 935 | 1 131 |

CAPELLO M3



| | Kč | Kč s DPH |
|------------|-----|----------|
| BB | 519 | 628 |
| PZ | 519 | 628 |
| WC | 727 | 880 |
| G/K | 779 | 943 |

CAPELLO M2



| | Kč | Kč s DPH |
|------------|-----|----------|
| BB | 519 | 628 |
| PZ | 519 | 628 |
| WC | 727 | 880 |
| G/K | 779 | 943 |

ANITA



M2

M3

| | Kč | Kč s DPH |
|------------|-----|----------|
| BB | 779 | 943 |
| PZ | 779 | 943 |
| WC | 961 | 1 163 |
| G/K | 961 | 1 163 |

ANITA M4



| | Kč | Kč s DPH |
|------------|-------|----------|
| BB | 857 | 1 037 |
| PZ | 857 | 1 037 |
| WC | 1 039 | 1 257 |
| G/K | 1 039 | 1 257 |

BEVERLY M4



| | Kč | Kč s DPH |
|------------|-------|----------|
| BB | 743 | 899 |
| PZ | 743 | 899 |
| WC | 925 | 1 119 |
| G/K | 1 029 | 1 245 |

MARCO M7/M9



| | Kč | Kč s DPH |
|-----------|-------|----------|
| BB | 857 | 1 037 |
| PZ | 857 | 1 037 |
| WC | 1 039 | 1 257 |

MARCO M4/M18



| | Kč | Kč s DPH |
|-----------|-------|----------|
| BB | 857 | 1 037 |
| PZ | 857 | 1 037 |
| WC | 1 039 | 1 257 |

MARCO M1/M2



| | Kč | Kč s DPH |
|-----------|-------|----------|
| BB | 857 | 1 037 |
| PZ | 857 | 1 037 |
| WC | 1 039 | 1 257 |

MATTEO M7/M9



| | Kč | Kč s DPH |
|-----------|-------|----------|
| BB | 857 | 1 037 |
| PZ | 857 | 1 037 |
| WC | 1 039 | 1 257 |

MATTEO M4/M18



| | Kč | Kč s DPH |
|-----------|-------|----------|
| BB | 857 | 1 037 |
| PZ | 857 | 1 037 |
| WC | 1 039 | 1 257 |

ANTINEA



| | Kč | Kč s DPH |
|------------|-----|----------|
| BB | 743 | 899 |
| PZ | 743 | 899 |
| WC | 925 | 1 119 |
| G/K | 925 | 1 119 |

AMANDA



| | Kč | Kč s DPH |
|------------|-----|----------|
| BB | 779 | 943 |
| PZ | 779 | 943 |
| WC | 961 | 1 163 |
| G/K | 961 | 1 163 |

AMANDA M3



| | Kč | Kč s DPH |
|------------|-----|----------|
| BB | 779 | 943 |
| PZ | 779 | 943 |
| WC | 961 | 1 163 |
| G/K | 961 | 1 163 |

ASTRAL

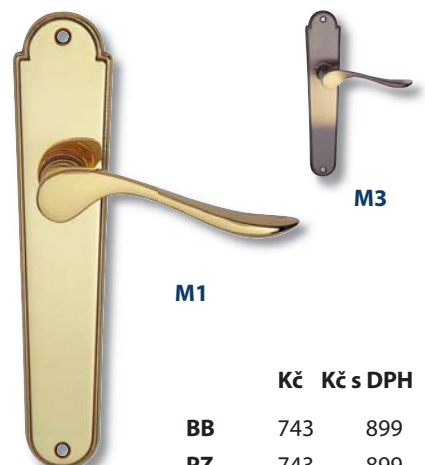

| | Kč | Kč s DPH |
|------------|-----|----------|
| BB | 743 | 899 |
| PZ | 743 | 899 |
| WC | 925 | 1 119 |
| G/K | 925 | 1 119 |

BEETHOVEN M3



| | Kč | Kč s DPH |
|------------|-------|----------|
| BB | 1 066 | 1 290 |
| PZ | 1 066 | 1 290 |
| WC | 1 274 | 1 542 |
| G/K | 1 274 | 1 542 |

BEETHOVEN M1



| | Kč | Kč s DPH |
|------------|-------|----------|
| BB | 1 066 | 1 290 |
| PZ | 1 066 | 1 290 |
| WC | 1 274 | 1 542 |
| G/K | 1 274 | 1 542 |

SUNNY



| | Kč | Kč s DPH |
|------------|-----|----------|
| M1 | | |
| BB | 779 | 943 |
| PZ | 779 | 943 |
| WC | 961 | 1 163 |
| G/K | 961 | 1 163 |

WIEN M1



| | Kč | Kč s DPH |
|------------|-----|----------|
| BB | 699 | 846 |
| PZ | 699 | 846 |
| WC | 881 | 1 066 |
| G/K | 881 | 1 066 |

ALTEA MC3



| | Kč | Kč s DPH |
|------------|-------|----------|
| BB | 854 | 1 033 |
| PZ | 854 | 1 033 |
| WC | 1 114 | 1 348 |
| G/K | 1 114 | 1 348 |

ALTEA M75



| | Kč | Kč s DPH |
|------------|-------|----------|
| BB | 1 134 | 1 372 |
| PZ | 1 134 | 1 372 |
| WC | 1 394 | 1 687 |
| G/K | 1 394 | 1 687 |

WIEN MC3



| | Kč | Kč s DPH |
|------------|-----|----------|
| BB | 699 | 846 |
| PZ | 699 | 846 |
| WC | 881 | 1 066 |
| G/K | 881 | 1 066 |



TOLOSA M75

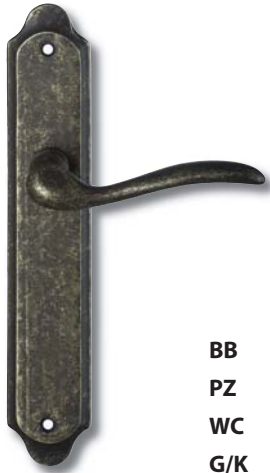

| | Kč | Kč s DPH |
|------------|-------|----------|
| BB | 1 034 | 1 251 |
| PZ | 1 034 | 1 251 |
| WC | 1 294 | 1 566 |
| G/K | 1 294 | 1 566 |

AREZIA M0



| | Kč | Kč s DPH |
|--------------|-----|----------|
| 72 BB | 718 | 869 |

ROMA M75



| | Kč | Kč s DPH |
|-----------|-------|----------|
| BB | 2 534 | 3 066 |
| PZ | 2 534 | 3 066 |
| WC | 2 810 | 3 400 |

FEDERICO M4



| | Kč | Kč s DPH |
|-----------|-------|----------|
| BB | 3 539 | 4 282 |
| PZ | 3 539 | 4 282 |
| WC | 3 965 | 4 798 |

ROMA R M69



| | Kč | Kč s DPH |
|-----------|-------|----------|
| BB | 3 443 | 4 166 |
| PZ | 3 443 | 4 166 |
| WC | 3 718 | 4 499 |

CARLO R M4



| | Kč | Kč s DPH |
|-----------|-------|----------|
| BB | 3 057 | 3 699 |
| PZ | 3 057 | 3 699 |
| WC | 3 497 | 4 231 |

FEDERICO R M75



| | Kč | Kč s DPH |
|-----------|-------|----------|
| BB | 3 374 | 4 083 |
| PZ | 3 374 | 4 083 |
| WC | 3 815 | 4 616 |

FEDERICO R M69



| | Kč | Kč s DPH |
|-----------|-------|----------|
| BB | 3 374 | 4 083 |
| PZ | 3 374 | 4 083 |
| WC | 3 815 | 4 616 |

ENRICO R



M18/nero



M1/nero

| | Kč | Kč s DPH |
|-----------|-------|----------|
| BB | 3 497 | 4 231 |
| PZ | 3 497 | 4 231 |
| WC | 3 916 | 4 738 |

LUX R



F1



F2

Kč Kč s DPH

| | | |
|-----|-----|-----|
| BB | 198 | 240 |
| PZ | 198 | 240 |
| WC | 285 | 345 |
| G/K | 285 | 345 |

LUX R



F4



F3

Kč Kč s DPH

| | | |
|-----|-----|-----|
| BB | 198 | 240 |
| PZ | 198 | 240 |
| WC | 285 | 345 |
| G/K | 285 | 345 |

LUX R



F12



F6

Kč Kč s DPH

| | | |
|----|-----|-----|
| BB | 302 | 365 |
| PZ | 302 | 365 |

LUCY R

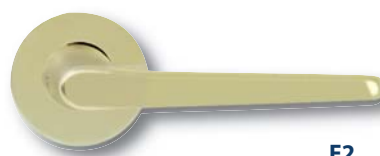

F2



F4

Kč Kč s DPH

| | | |
|-----|-----|-----|
| BB | 207 | 250 |
| PZ | 207 | 250 |
| WC | 302 | 365 |
| G/K | 302 | 365 |

OMEGA R F1



Kč Kč s DPH

| | | |
|-----|-----|-----|
| BB | 233 | 282 |
| PZ | 233 | 282 |
| WC | 311 | 376 |
| G/K | 311 | 376 |

VERENA R



F1



F9

Kč Kč s DPH

| | | |
|-----|-----|-----|
| BB | 297 | 359 |
| PZ | 297 | 359 |
| WC | 401 | 485 |
| G/K | 401 | 485 |

GOLF R



F1



F4

Kč Kč s DPH

| | | |
|-----|-----|-----|
| BB | 260 | 315 |
| PZ | 260 | 315 |
| WC | 325 | 393 |
| G/K | 325 | 393 |

MODERN R



F1



F2

Kč Kč s DPH

| | | |
|-----|-----|-----|
| BB | 259 | 313 |
| PZ | 259 | 313 |
| WC | 358 | 433 |
| G/K | 358 | 433 |

REA R



F1



F9

Kč Kč s DPH

| | | |
|-----|-----|-----|
| BB | 245 | 296 |
| PZ | 245 | 296 |
| WC | 346 | 419 |
| G/K | 346 | 419 |

hliníkové kliky

EMERALD R F1



| | Kč | Kč s DPH |
|------------|-----|----------|
| BB | 249 | 301 |
| PZ | 249 | 301 |
| WC | 346 | 419 |
| G/K | 346 | 419 |

EMA R



F1

F9



| | Kč | Kč s DPH |
|------------|-----|----------|
| BB | 271 | 328 |
| PZ | 271 | 328 |
| WC | 362 | 438 |
| G/K | 362 | 438 |

EMA S



F1

F9



| | Kč | Kč s DPH |
|------------|-----|----------|
| BB | 363 | 439 |
| PZ | 363 | 439 |
| WC | 493 | 597 |
| G/K | 493 | 597 |

LUX I F1



| | Kč | Kč s DPH |
|------------|-----|----------|
| BB | 181 | 219 |
| PZ | 181 | 219 |
| WC | 259 | 313 |
| G/K | 259 | 313 |

LUX I F4



| | Kč | Kč s DPH |
|------------|-----|----------|
| BB | 181 | 219 |
| PZ | 181 | 219 |
| WC | 259 | 313 |
| G/K | 259 | 313 |

LUX I F2



| | Kč | Kč s DPH |
|------------|-----|----------|
| BB | 181 | 219 |
| PZ | 181 | 219 |
| WC | 259 | 313 |
| G/K | 259 | 313 |

LUCY F4



| | Kč | Kč s DPH |
|------------|-----|----------|
| BB | 181 | 219 |
| PZ | 181 | 219 |
| WC | 245 | 296 |
| G/K | 259 | 313 |

LUCY F2



| | Kč | Kč s DPH |
|------------|-----|----------|
| BB | 181 | 219 |
| PZ | 181 | 219 |
| WC | 245 | 296 |
| G/K | 259 | 313 |

LUX X



F6

F12

| | Kč | Kč s DPH |
|--------------|-----|----------|
| 92 PZ | 250 | 303 |

hliníkové kliky

LUX F1



| | Kč | Kč s DPH |
|------------|-----|----------|
| BB | 170 | 206 |
| PZ | 170 | 206 |
| WC | 238 | 288 |
| G/K | 259 | 313 |

LUX F3



| | Kč | Kč s DPH |
|-----------|-----|----------|
| BB | 170 | 206 |
| PZ | 170 | 206 |

LUX

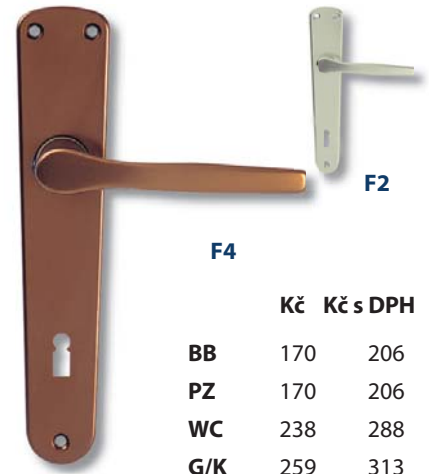

| | Kč | Kč s DPH |
|------------|-----|----------|
| BB | 170 | 206 |
| PZ | 170 | 206 |
| WC | 238 | 288 |
| G/K | 259 | 313 |

EMERALD F1



| | Kč | Kč s DPH |
|------------|-----|----------|
| BB | 259 | 313 |
| PZ | 259 | 313 |
| WC | 303 | 367 |
| G/K | 303 | 367 |

VERENA

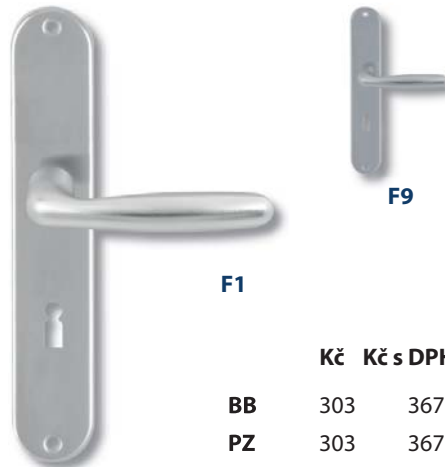

| | Kč | Kč s DPH |
|------------|-----|----------|
| BB | 303 | 367 |
| PZ | 303 | 367 |
| WC | 337 | 408 |
| G/K | 337 | 408 |

MODERN

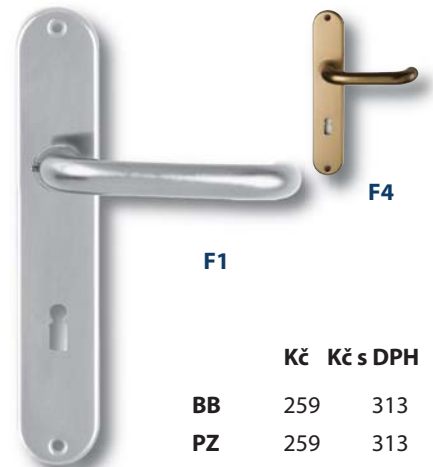

| | Kč | Kč s DPH |
|------------|-----|----------|
| BB | 259 | 313 |
| PZ | 259 | 313 |
| WC | 358 | 433 |
| G/K | 358 | 433 |

EMA

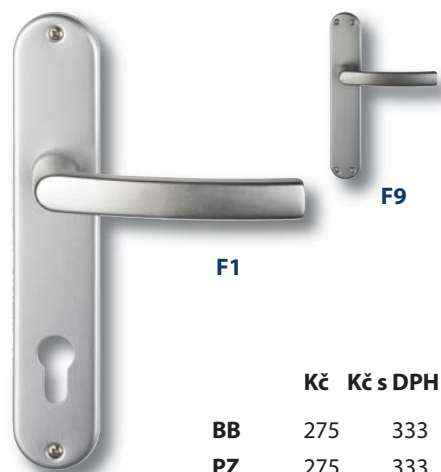

| | Kč | Kč s DPH |
|------------|-----|----------|
| BB | 275 | 333 |
| PZ | 275 | 333 |
| WC | 320 | 387 |
| G/K | 320 | 387 |

OMEGA F1



| | Kč | Kč s DPH |
|------------|-----|----------|
| BB | 233 | 282 |
| PZ | 233 | 282 |
| WC | 311 | 376 |
| G/K | 311 | 376 |



DEA PŮLOLIVA



| | Kč | Kč s DPH |
|-----------|-----|----------|
| M1 | 247 | 299 |
| M3 | 247 | 299 |
| M4 | 247 | 299 |
| M9 | 247 | 299 |

ELEGANT PŮLOLIVA



| | Kč | Kč s DPH |
|-----------|-----|----------|
| M1 | 247 | 299 |
| M2 | 247 | 299 |
| M9 | 247 | 299 |

DEA OLIVA



| | Kč | Kč s DPH |
|-----------|-----|----------|
| M1 | 247 | 299 |
| M2 | 247 | 299 |
| M3 | 247 | 299 |
| M4 | 247 | 299 |
| M9 | 247 | 299 |

LUNA DK



s polohovacím mechanismem
(na eurookna)

| | Kč | Kč s DPH |
|------------|-----|----------|
| M1 | 311 | 376 |
| MC3 | 311 | 376 |
| M9 | 311 | 376 |

PŮLOLIVY DK



Valeria

Antinea

s polohovacím mechanismem
(na eurookna)

| | Kč | Kč s DPH |
|----------------------|-----|----------|
| Valeria DK M1 | 415 | 502 |
| Antinea DK M3 | 415 | 502 |

DEDRA DK



s polohovacím mechanismem
(na eurookna)

| | Kč | Kč s DPH |
|-----------|-----|----------|
| M2 | 363 | 439 |
| M3 | 363 | 439 |
| M4 | 415 | 502 |
| M9 | 415 | 502 |

OMEGA DK



s polohovacím mechanismem
(na eurookna)

| | Kč | Kč s DPH |
|------------|-----|----------|
| MC3 | 311 | 376 |
| M4 | 311 | 376 |
| M9 | 311 | 376 |

MUSA DK



s polohovacím mechanismem
(na eurookna)

| | Kč | Kč s DPH |
|-----------|-----|----------|
| M4 | 520 | 629 |

APPIA DK



s polohovacím mechanismem
(na eurookna)

| | Kč | Kč s DPH |
|------------|-----|----------|
| M4 | 650 | 787 |
| M9 | 650 | 787 |
| M18 | 650 | 787 |

PŮLOLIVY DK



Quattro

Tecno

s polohovacím mechanismem
(na eurookna)

| | Kč | Kč s DPH |
|----------------------|-----|----------|
| Quattro DK M9 | 494 | 598 |
| Tecno DK M9 | 598 | 724 |

PŮLOLIVY



Dedra

Oasi

Vivien

| | Kč | Kč s DPH |
|--------------------------|-----|----------|
| Dedra pololiva M1 | 207 | 250 |
| Oasi DK M1 | 311 | 376 |
| Vivien DK M4/M15 | 467 | 565 |

ROZVORY



Antinea

Dedra

Kč Kč s DPH

| | | |
|--------------------|-----|-----|
| Antinea rozvora M1 | 441 | 534 |
| Dedra rozvora M3 | 337 | 408 |
| Dedra rozvora M4 | 389 | 471 |

ELEGANT ROZVORA



M1

MC3

Kč Kč s DPH

| | | |
|-----|-----|-----|
| M1 | 337 | 408 |
| MC3 | 337 | 408 |

WIEN



Kč Kč s DPH

| | | |
|----------------------|-----|-----|
| Alt Wien rozvora M1 | 656 | 794 |
| Alt Wien pololiva M1 | 494 | 598 |

PŮLLOLIVY DK



M15

Tipo

Uno

Lido

Kč Kč s DPH

| | | |
|---------|-----|-----|
| Tipo DK | 311 | 376 |
| Uno DK | 311 | 376 |
| Lido DK | 311 | 376 |

PŮLLOLIVY DK



M15

Tino

Fiona

Kč Kč s DPH

| | | |
|----------|-----|-----|
| Tino DK | 337 | 408 |
| Fiona DK | 337 | 408 |

PŮLLOLIVY DK



M15

Tipo

Uno

Lido

Kč Kč s DPH

| | | |
|---------|-----|-----|
| Tipo DK | 337 | 408 |
| Uno DK | 337 | 408 |
| Lido DK | 337 | 408 |

PŮLLOLIVY DK



M15

Tino

Fiona

Kč Kč s DPH

| | | |
|----------|-----|-----|
| Tino DK | 363 | 439 |
| Fiona DK | 363 | 439 |

PŮLLOLIVA 2010

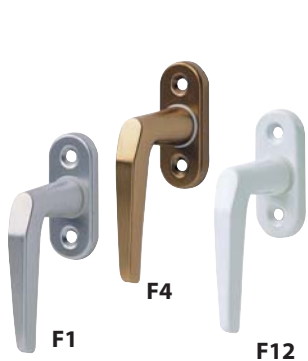

F1

F4

F12

Kč Kč s DPH

| | | |
|-----|----|----|
| F1 | 76 | 92 |
| F4 | 76 | 92 |
| F12 | 76 | 92 |

OLIVA 3013



Kč Kč s DPH

| | | |
|-----|----|-----|
| F1 | 90 | 109 |
| F2 | 90 | 109 |
| F4 | 90 | 109 |
| F12 | 90 | 109 |

PŮLLOLIVY



2013

4010 DK

Kč Kč s DPH

| | | |
|---------------------|-----|-----|
| Pololiva 2013 F1 | 81 | 98 |
| Pololiva 2013 F2 | 81 | 98 |
| Pololiva 4010 DK F1 | 143 | 173 |
| Pololiva 4010 DK F4 | 143 | 173 |

30 GU

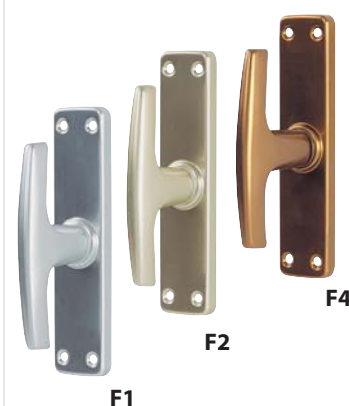

F1

F2

F4

Kč Kč s DPH

| | | |
|---------------|-----|-----|
| Oliva 30 GU | 162 | 196 |
| Rozvora 30 GU | 216 | 261 |

ALPHA E M

| | Kč | Kč s DPH |
|----|-----|----------|
| F1 | 819 | 991 |
| F4 | 819 | 991 |
| F9 | 936 | 1 133 |

ALPHA E II

| | Kč | Kč s DPH |
|----|-----|----------|
| F1 | 819 | 991 |
| F4 | 819 | 991 |
| F9 | 936 | 1 133 |

BEZPEČNOSTNÍ ROZETA 7030

| | Kč | Kč s DPH |
|----|-----|----------|
| F1 | 649 | 785 |
| F2 | 649 | 785 |
| F4 | 649 | 785 |
| F9 | 649 | 785 |

BEZPEČNOST

- spolehlivá ochrana proti vloupání
- certifikované v bezpečnostní třídě 3 – stupeň vysoké ochrany
- **certifikát NBÚ T10-0743/2005 pro stupeň utajení TAJNÉ**, platný do 24.06.2015
- lichoběžníkový tvar štítu zmírní nárazy jakéhokoliv náradí
- překrytí vložky – ochrana proti nedovolené manipulaci
- z vnější strany kování není možné demontovat anebo odcizit
- **celoocelové svorníky a šrouby** znemožňují odvrtání a násilnou demontáž

KVALITA

- značkový výrobek prestižního německého výrobce – záruka vysoké kvality
- **vysoko odolný legovaný hliník** – záruka pevnosti
- vícenásobná galvanizace povrchu – vysoká odolnost vůči opotřebování
- pevný **vnější štít tloušťky 15 mm** z masivního materiálu
- design Dieckmann: hranatý anebo oválný

JEDNODUCHÁ MONTÁŽ

- jednoduchá výměna starého kování za nové – možnost rozpětí šroubů jako na kování R1
- **odpružené překrytí** bezpečnostní vložky se přizpůsobí vložce přečnávající ze dveří
- kování je pravolevé – **bezproblémová montáž**

VYHOTOVENÍ

- ✓ povrchy: hliník stříbrný (F1), hliník bronzový (F4) a hliník nerez (F9)
- ✓ rozteče: 72 mm, 90 mm, 92 mm, pokud není uvedeno jinak (jak změřit rozteč kování se dozvíte na str. 2)
- ✓ součástí balení je i spojovací materiál na tloušťku dveří 40-45 mm
- ✓ nestandardní rozměry (69-75 mm, 79-85 mm) za příplatek

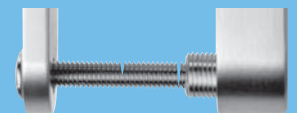

ALPHA SAFE M

| | Kč | Kč s DPH |
|----|-------|----------|
| F1 | 1 326 | 1 604 |
| F4 | 1 430 | 1 730 |
| F9 | 1 430 | 1 730 |

ALPHA SAFE II

| | Kč | Kč s DPH |
|----|-------|----------|
| F1 | 1 222 | 1 479 |
| F4 | 1 326 | 1 604 |
| F9 | 1 326 | 1 604 |

BEZPEČNOSTNÍ ROZETA 7031 SAFE

| | Kč | Kč s DPH |
|----|-----|----------|
| F1 | 812 | 983 |
| F4 | 892 | 1 079 |

ROMBUS M

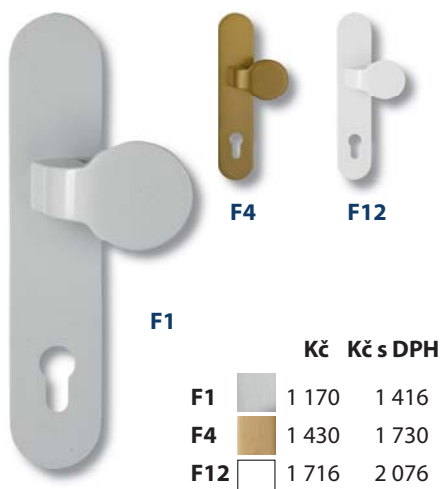

| | Kč | Kč s DPH |
|-----|-------|----------|
| F1 | 1 170 | 1 416 |
| F4 | 1 430 | 1 730 |
| F12 | 1 716 | 2 076 |

ROMBUS II

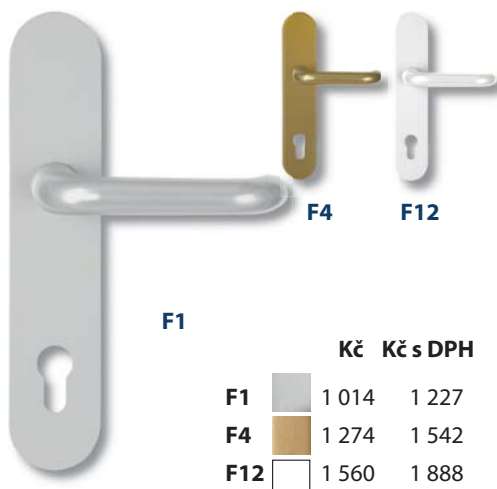

| | Kč | Kč s DPH |
|-----|-------|----------|
| F1 | 1 014 | 1 227 |
| F4 | 1 274 | 1 542 |
| F12 | 1 560 | 1 888 |

BEZPEČNOSTNÍ ROZETA 6532



| | Kč | Kč s DPH |
|-----|-----|----------|
| F1 | 363 | 439 |
| F2 | 363 | 439 |
| F4 | 363 | 439 |
| F9 | 363 | 439 |
| F12 | 363 | 439 |

ROMBUS SAFE M

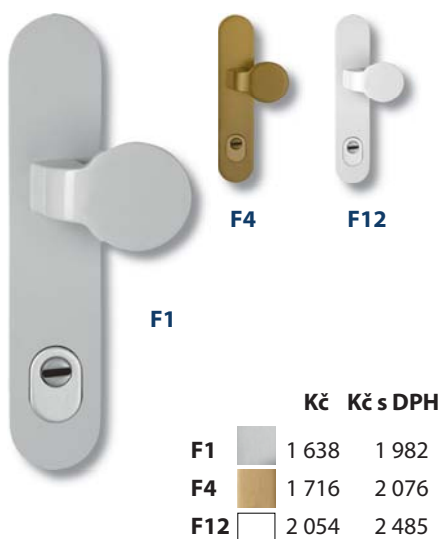

| | Kč | Kč s DPH |
|-----|-------|----------|
| F1 | 1 638 | 1 982 |
| F4 | 1 716 | 2 076 |
| F12 | 2 054 | 2 485 |

ROMBUS SAFE II

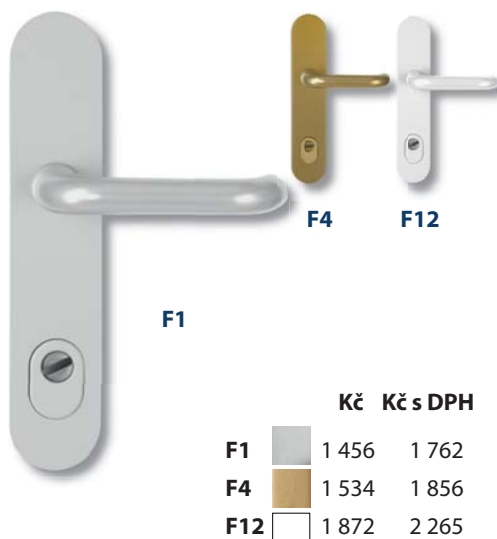

| | Kč | Kč s DPH |
|-----|-------|----------|
| F1 | 1 456 | 1 762 |
| F4 | 1 534 | 1 856 |
| F12 | 1 872 | 2 265 |

BEZPEČNOSTNÍ ROZETA 7156



| | Kč | Kč s DPH |
|----|-----|----------|
| F1 | 550 | 666 |
| F2 | 550 | 666 |
| F4 | 605 | 732 |
| F9 | 605 | 732 |

FORTE M F1



92 mm

| | Kč | Kč s DPH |
|-------|-----|----------|
| 92 mm | 759 | 918 |

STRONG SAFE M F9

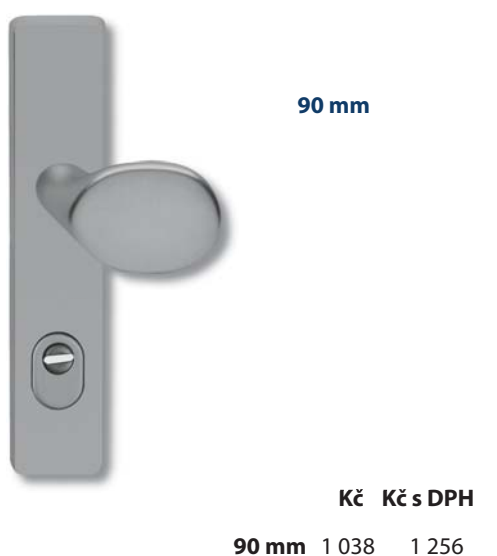

90 mm

| | Kč | Kč s DPH |
|-------|-------|----------|
| 90 mm | 1 038 | 1 256 |

HERCULES II



90 mm

92 mm

F12

F2

| | Kč | Kč s DPH |
|-----|-----|----------|
| F2 | 623 | 754 |
| F12 | 623 | 754 |

628 M1



madlo/klika

Kč Kč s DPH
3 080 3 727

621 M1



koule/klika

Kč Kč s DPH
3 080 3 727

608 M1



klika/klika

Kč Kč s DPH
2 587 3 130

628 M3



madlo/klika

Kč Kč s DPH
3 080 3 727

621 M3



koule/klika

Kč Kč s DPH
3 080 3 727

608 M3



klika/klika

Kč Kč s DPH
2 587 3 130

844



M1

M3

klika/klika

Kč Kč s DPH
1 620 1 960

842

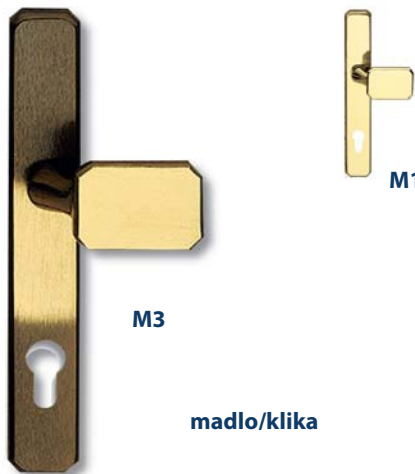

M3

M1

madlo/klika

Kč Kč s DPH
1 936 2 343

328 M M9



madlo/klika

Kč Kč s DPH
2 327 2 816

428 M4/M9



madlo/klika

Kč Kč s DPH
3 361 4 067

408 M4/M9



klika/klika

Kč Kč s DPH
3 080 3 727

TORNADO 419 M1



madlo/klika

Kč Kč s DPH
3 603 4 360

OKTAN 412 M1



madlo/klika

Kč Kč s DPH
2 327 2 816

OKTAN 404/50



klika/klika

Kč Kč s DPH
2 587 3 130

OKTAN 404/703



klika/klika

Kč Kč s DPH
2 587 3 130

310 G M1



koule/klika

Kč Kč s DPH
2 587 3 130

K 328 SAFE M M1



madlo/klika

Kč Kč s DPH
2 574 3 115



822 M M1



824 II M1

Kč Kč s DPH
822 M M1 728 881
824 II M1 650 787

KRONOS II

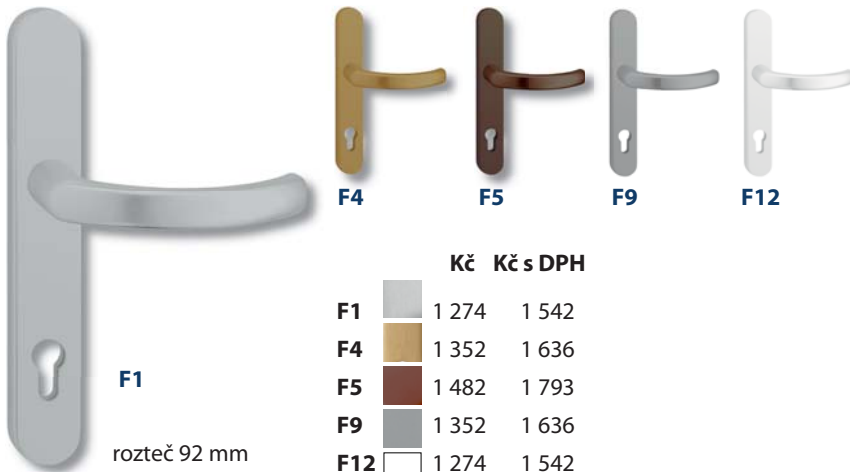

| | Kč | Kč s DPH |
|-----|-------|----------|
| F1 | 1 274 | 1 542 |
| F4 | 1 352 | 1 636 |
| F5 | 1 482 | 1 793 |
| F9 | 1 352 | 1 636 |
| F12 | 1 274 | 1 542 |

F1

rozteč 92 mm

KRONOS M

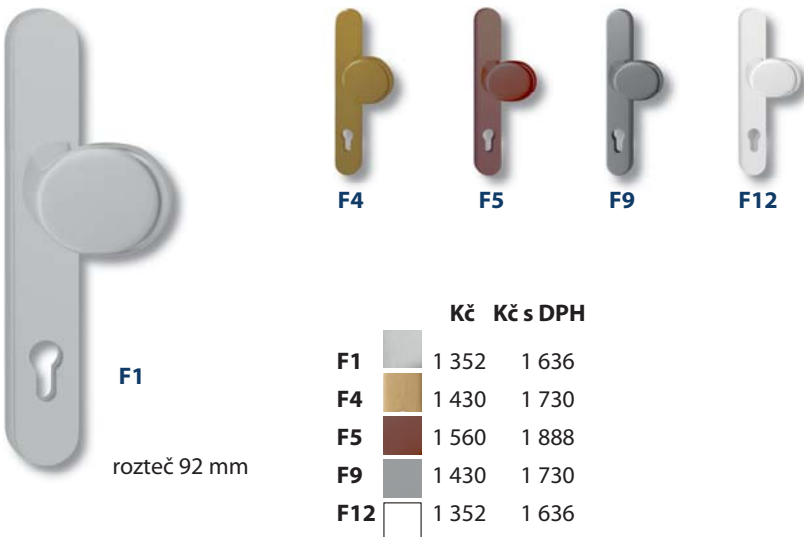

| | Kč | Kč s DPH |
|-----|-------|----------|
| F1 | 1 352 | 1 636 |
| F4 | 1 430 | 1 730 |
| F5 | 1 560 | 1 888 |
| F9 | 1 430 | 1 730 |
| F12 | 1 352 | 1 636 |

F1

rozteč 92 mm

KRONOS SAFE M



KRONOS SAFE II

| | Kč | Kč s DPH |
|-----|-------|----------|
| F1 | 1 690 | 2 045 |
| F4 | 1 807 | 2 186 |
| F5 | 1 924 | 2 328 |
| F9 | 1 807 | 2 186 |
| F12 | 1 690 | 2 045 |

KRONOS SAFE M

| | Kč | Kč s DPH |
|-----|-------|----------|
| F1 | 1 807 | 2 186 |
| F4 | 1 963 | 2 375 |
| F5 | 2 234 | 2 703 |
| F9 | 1 963 | 2 375 |
| F12 | 1 807 | 2 186 |

F1

rozteč 92 mm

KRONOS F4/F12

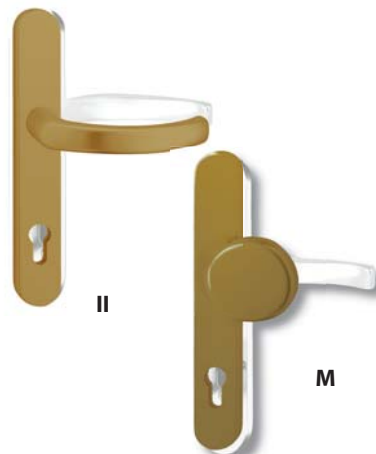

| | Kč | Kč s DPH |
|----|-------|----------|
| II | 1 482 | 1 793 |
| M | 1 560 | 1 888 |

II
M

KRONOS R9

vnější klika vhodná pod roletu

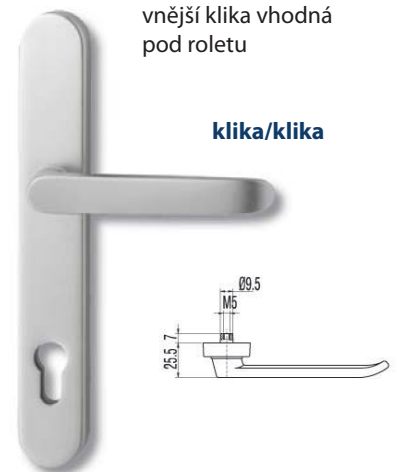

klika/klika

| | Kč | Kč s DPH |
|-----|-------|----------|
| F12 | 1 688 | 2 042 |

NOVINKA 2013

kování na okna a dveře z profilů

KOMU JE KATALOG URČEN:

- každému, kdo uvažuje o hliníkových nebo plastových oknech či dveřích
- výrobcům a prodejčům hliníkových a plastových oken a dveří
- stavebním firmám
- architektům a projektantům

CO V KATALOGU NALEZNETE:



- kliky na okna
- kliky na dveře
- protipožární kování v 4. třídě zatížení
- bezpečnostní kování
- bezpečnostní vložky
- cylindrické vložky
- bezpečnostní rozety
- madla na vchodové dveře

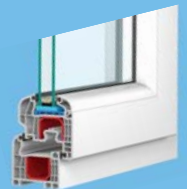

ALBA F1



1200/2033 *



1200/2034 *



protipožární certifikát

| Kč | Kč s DPH |
|-----|----------|
| 624 | 755 |

ALBA F1



2000/2033 *



2000/2034 *

| Kč | Kč s DPH |
|-----|----------|
| 624 | 755 |

ROZETY F1



812 PZ * 813 BL *

síla 6 mm

811 PZ *

Kč Kč s DPH

| | | |
|-----|-----|-----|
| 811 | 216 | 261 |
| 812 | 216 | 261 |
| 813 | 216 | 261 |

PLAYA MADLO F1



K4/2033 *



K4/2034 *

| Kč | Kč s DPH |
|-----|----------|
| 905 | 1 095 |

RONDO C M15



rozteč 90 a 92 mm



| Kč | Kč s DPH |
|-------|----------|
| 1 286 | 1 556 |

RONDO MADLO M15



67170 *

67172 *



| Kč | Kč s DPH |
|-------|----------|
| 67170 | 689 834 |
| 67172 | 603 730 |

KRONOS B1



madlo/klika

| | Kč | Kč s DPH |
|-----|-------|----------|
| F1 | 1 693 | 2 049 |
| F4 | 1 693 | 2 049 |
| F5 | 1 794 | 2 171 |
| F9 | 1 693 | 2 049 |
| F12 | 1 693 | 2 049 |

KRONOS 1200



všechna kování Kronos dostupná i s klikou 1200 ve všech barvách



MADLO ROMA F1

MADLO ROMA F12

MADLO ROMANA F1

MADLO ROMANA F12

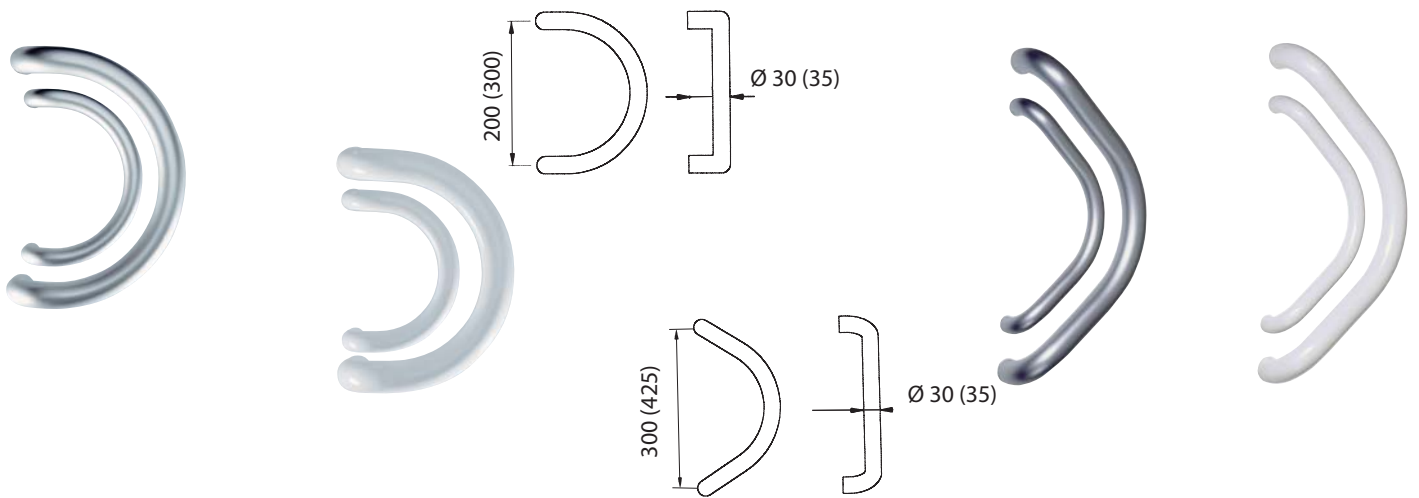

antikorozní ocel
AISI 304



záruka 10 let

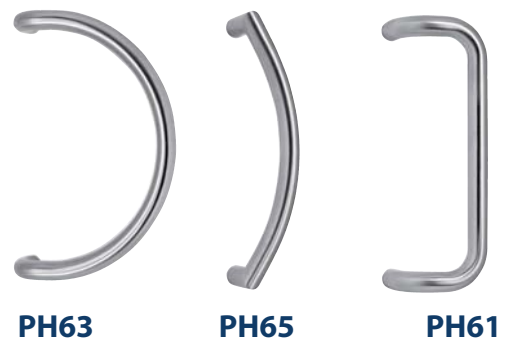

www.madlo.eu

Naleznete:

- technické specifikace
- rozměry
- ceny
- více modelů a doplňků

Na dveře:

- skleněné
- hliníkové
- plastové
- dřevěné

Upevnění:

- jednostranné
- oboustranné

MADLA TESERO

BEZPEČNOSTNÍ ROZETY (ks)

**KLIKY
K JEDNOSTRANNÝM MADLŮM**



92450 - 6 mm
428 Kč / 518 Kč

92451 - 10 mm
497 Kč / 601 Kč

92452 - 15 mm
580 Kč / 702 Kč

92455 - 15 mm
690 Kč / 835 Kč



92460 - 6 mm
483 Kč / 584 Kč

92461 - 10 mm
552 Kč / 668 Kč

92462 - 15 mm
635 Kč / 768 Kč

92465 - 15 mm
745 Kč / 901 Kč



Tipo UK *
440 Kč / 532 Kč



Lido UK *
440 Kč / 532 Kč



Clara UK *
492 Kč / 595 Kč

- celokovová masivní konstrukce
- jednoduchá montáž
- bez viditelných šroubů
- vrchní krytku není možné demontovat, pokud je ve dveřích bezpečnostní vložka



čtyřhran
s háčkem
na montáž
jednostranné kliky

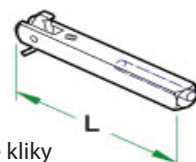



Bezpečnost je pocit – my ho měníme na skutečnost

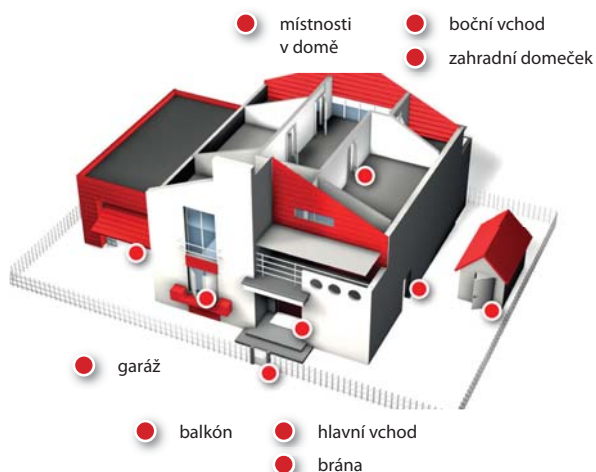

KDE MÁM KLÍČ OD GARÁŽE?

Ve vícečlenné domácnosti může být někdy těžké mít pod kontrolou klíče od brány, vchodu, či garáže. Buď nosí každý z Vás těžký svazek anebo soustavně hledáte klíče, které právě potřebujete. S řešením DOM se zbavíte svazků klíčů a už je nikdy nebudete hledat. Budete mít jistotu, že **správný klíč je vždy po ruce.**

KDO MĚL PŘÍSTUP DO KANCELÁŘE, ODKUD ZMIZEL POČÍTAČ?

Máte dokonalou kontrolu nad pohybem osob ve firmě? Je možné přesně zjistit, kdo má přístup do archivu k nejcennějším datům? Kolik klíčů je potřeba vyrobit novému zaměstnanci? Může někdo vstoupit do firmy po pracovní době? S řešením DOM přesně vymezíte **přístupová práva osob podle jejich kompetencí.** Předvedete škodám či problémům spojených s nepřehlednou evidencí klíčů a lehčeji vyvodíte osobní zodpovědnost.

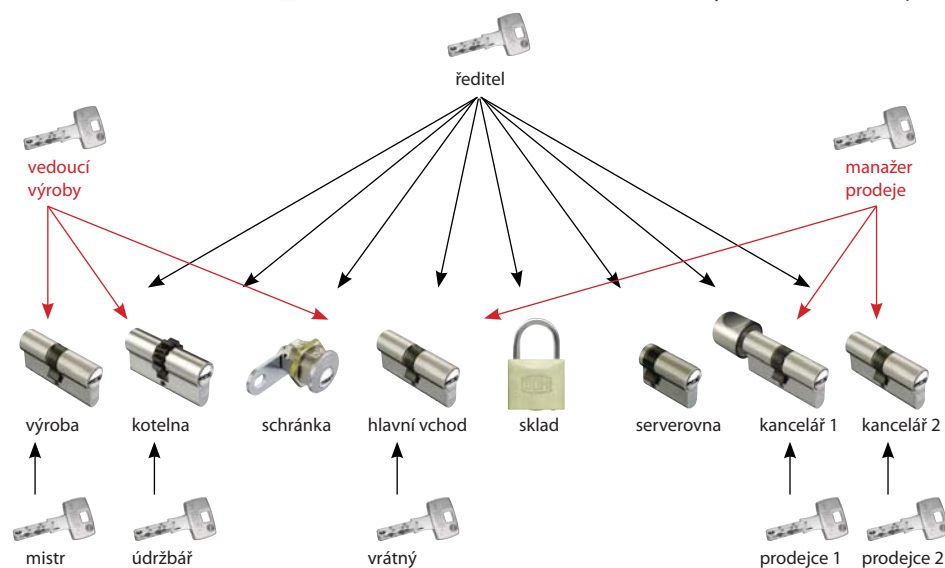

Dejte nám vědět Vaše požadavky a my Vám navrhneme řešení, se kterým budete spokojeni.

Zařadíte se tak mezi **spokojené Čechy a Slováky**, kteří denně používají víc jak **1 200 systémů generálního klíče** z dílny Metalie.

VÝHODY SYSTÉMU GENERÁLNÍHO KLÍČE

- ✓ **komfortní odemykání vícero dveří jedním klíčem**
- ✓ **menší počet klíčů** – větší pohodlí
- ✓ **zvýšení bezpečnosti** vůči napadení – zvenku i zevnitř z řad Vašich lidí (tiché vloupání)
- ✓ **časová úspora** – čas, který byste jinak strávili hledáním správného klíče při každém odemykání a zamykání
- ✓ **pořádek na pracovišti** – všichni budou na místě, které jim určíte, a nedostanou se tam, kam nesmí
- ✓ **jednoduché spravování klíčů** – přehledná mapa všech přístupových práv
- ✓ **prevence** proti škodám – např. krádeže ze skladu nepovolanými zaměstnanci
- ✓ **finanční úspora** za údržbu – bezporuchovost klíčů a vložek, pouze sporadický servis
- ✓ **výrazně zvýšená flexibilita** – integrace s elektronickým uzamknutím (více na straně 35)
- ✓ **osobní zodpovědnost** zaměstnanců – individuální značení klíčů pro konkrétní osoby
- ✓ **ochrana investice** do uzamknutí – uzamykací systém může být kdykoliv rozšířen a upravován při organizačních změnách
- ✓ **22-ti letá zkušenost** – oceníte jí při tvorbě Vašeho individuálního řešení (více jak 1 200 systémů s generálním klíčem vyrobených v naší dílně)
- ✓ **okamžitý servis** – změna přístupových práv, výroba dodatečných klíčů či vložek zpravidla do 2-48 hodin, dodávka do několika pracovních dnů

Potřebujete s něčím poradit? Zavolejte nám na +420 542 212 568

BEZPEČNOST

Firma DOM je po celá desetiletí držitelem těch nejlepších certifikátů. Nejvyšší úroveň ochrany před napadením. Vysoký počet autorizačních bodů Vás ochrání před všemi moderními metodami napadení včetně nedestruktivní dynamické metody „SG„ (bumping).

KOMFORT

Odemykání si doslova zamilujete. Tento zážitek Vám zaručí v první řadě ochrana proti zalomení klíče, protože postačí menší síla na plynulé, hladké otáčení. Vložka s kónickým vstupem a vylepšená náběhová hrana klíče zabezpečuje pohodlné vložení. Hlavička klíče je tvarovaná na šikvné uchopení, klíče z alpaky se neohýbají, nelámou a nerezaví.

Váš komfort je umocněn okamžitým plněním požadavků na míru, podle individuálních potřeb.

ABSOLUTNÍ KONTROLA NAD VÝROBOU DUPLIKÁTŮ KLÍČŮ

Klíč DOM se stal symbolem bezpečnosti díky nejmodernější technologické ochraně proti výrobě duplikátů klíčů. Vložky DOM jsou vyrobené s nejvyšší přesností, a proto se duplikáty klíčů nevyrobí na běžných konvenčních kopírovacích strojích, nevyrobí se v klíčových službách. Délka patentové ochrany odpovídá požadavkům nejvyšší bezpečnosti a ochrany. Klíče Vám po předložení karty vyrobí pouze výrobce vložek – Metalia.

SPOLEHLIVOST

Důvěřujte nejprestižnější značce na německém trhu. Uvidíte, že vložky DOM spolehlivě fungují dlouhé roky. Díky prvotřídnímu materiálu a mistrovskému opracování s nejvyšší přesností se duplikáty DOM nevyrobí od klíče, každý klíč DOM se vyrábí jako originál.

SERVIS

Spolehněte se na záruční a pozáruční servis všech našich výrobků:

- výroba klíčů a sjednocení vložek
- překódování vložky v případě ztráty klíče
- změna rozměrů vložky
- revitalizace a jiné...

Bližší informace o řešení DOM v katalogu **Bezpečnost na 1. místě**, který naleznete i na

www.ap-metalia.cz



nouzová funkce emergency („T“) umožní otevřít dveře, i když je z vnitřní strany zasunutý klíč

SK: shodný kód umožňuje otevřít dvě nebo více vložek stejným klíčem

dodatečné klíče pouze po předložení bezpečnostní karty

ochrana proti odvrtání vložky

pohyblivý disk v klíči

technologická ochrana proti kopírování klíče

vložka je dostupná v uzamykacích systémech

vložka dostupná v různých provedení (např. vložka do dveří, skříňková vložka, visací zámek, okenní ...)

vložka certifikovaná podle normy STN EN 1303

patentová ochrana do xxxx

VdS certifikát

DIN EN 1303

DOM ix 6 SR plus

Vysoký stupeň ochrany domu, bytu, firmy a obchodních prostorů



✓ **extrémně vysoká ochrana** proti odvrtání a vytrhnutí jádra

✓ **nejvyšší technologická ochrana proti kopírování klíče** - pohyblivý disk v klíči

✓ **vysoká ochrana proti manipulaci** 2 odpružené horizontální závory až 23 autorizačních bodů na klíči znemožňuje překonání vložky

✓ **dlouhodobá patentová ochrana**



třída bezpečnosti klíče 6 (STN EN 1303)
třída odolnosti 4 (STN P ENV 1627)
NBÚ „přísně tajné“
odolá dynamické SG metodě („bumping“)

3 233 Kč / 3 912 Kč

DIN EN 1303

DOM ix 6 SR

Vysoký stupeň ochrany domu, bytu, firmy a obchodních prostorů



✓ **zvýšená ochrana** proti odvrtání a vytrhnutí jádra

✓ **nejvyšší technologická ochrana proti kopírování klíče** - pohyblivý disk v klíči

✓ **vysoká ochrana proti manipulaci** 1 odpružená horizontální závora až 23 autorizačních bodů na klíči znemožňuje překonání vložky

✓ **dlouhodobá patentová ochrana**



třída bezpečnosti klíče 6 (STN EN 1303)
třída odolnosti 4 (STN P ENV 1627)
NBÚ „přísně tajné“
odolá dynamické SG metodě („bumping“)

2 811 Kč / 3 401 Kč

DIN EN 1303

DOM ix DAS

Zvýšený stupeň ochrany vchodových dveří do domu, bytu, kanceláří



✓ **zvýšená ochrana** proti odvrtání a vytrhnutí jádra

✓ **vysoká technologická ochrana proti kopírování klíče** technologie „high-deep“ – profil klíče znemožňuje výrobu duplikátů vysoký počet autorizačních bodů na klíči (21) chrání před moderními metodami překonání a manipulace

✓ **dlouhodobá patentová ochrana**

✓ nejvyšší komfort a spolehlivost – klíče z alpaky se neohýbají



třída bezpečnosti klíče 6 (STN EN 1303)
třída odolnosti 4 (STN P ENV 1627)
NBÚ „přísně tajné“
odolá dynamické SG metodě („bumping“)

2 262 Kč / 2 737 Kč

DOM Protector®



- ✓ bezpečnostní mechatronická vložka s čtečkou – elektronická kontrola vstupů
- ✓ flexibilní systém přístupových práv – okamžité řešení při ztrátě klíče, přijmutí nového zaměstnance, zastupování anebo návštěvě
- ✓ přesné určení přístupových práv – definování časových zón
- ✓ paměť až do 3 000 uživatelů
- ✓ zaznamenává posledních až 2 000 událostí (vstupy, pokusy...)
- ✓ různé dodatečné funkce – zákaz opakovaného vstupu, autorizace 2 osobami, dlouhodobě otevřené...
- ✓ jednoduchá obsluha a programování (pomocí Master karty anebo Vašeho PC)
- ✓ jednoduchá montáž bez kabelů a zásahů do dveří a kování – rozměry totožné s mechatronickou vložkou (otvor PZ)
- ✓ vodotěsnost – IP65



od 13 572 Kč / 16 422 Kč

DOM Access Manager



- ✓ čtečka přístupových karet, transpondérů a elektronických klíčů – elektronická kontrola vstupů
- ✓ flexibilní systém přístupových práv – okamžité řešení při ztrátě klíče, přijmutí nového zaměstnance, zastupování anebo návštěvě
- ✓ přesné určení přístupových práv – definování časových zón
- ✓ paměť až do 3 000 uživatelů
- ✓ zaznamenává posledních až 3 000 událostí (vstupy, pokusy...)
- ✓ množství dodatečných funkcí – zákaz opakovaného vstupu, autorizace 2 osobami, počítání osob, délka návštěvy mezi příchodem a odchodem, nastavitelný povinný časový odstup mezi jednotlivými dveřmi...
- ✓ jednoduchá obsluha a programování (pomocí Master karty anebo Vašeho PC)

od 12 012 Kč / 14 535 Kč

DOM Guardian®



- ✓ mechatronické kování s čtečkou – elektronická kontrola vstupů
- ✓ flexibilní systém přístupových práv – okamžité řešení při ztrátě klíče, přijmutí nového zaměstnance, zastupování anebo návštěvě
- ✓ přesné určení přístupových práv – definování časových zón
- ✓ paměť až do 3 000 uživatelů
- ✓ zaznamenává posledních až 2 000 událostí (vstupy, pokusy...)
- ✓ různé dodatečné funkce – zákaz opakovaného vstupu, autorizace 2 osobami, dlouhodobě otevřené...
- ✓ jednoduchá obsluha a programování (pomocí Master karty anebo Vašeho PC)
- ✓ jednoduchá montáž bez kabelů
- ✓ šířka štítu 38 mm – vhodné aj na dveře z úzkých profilů

od 13 624 Kč / 16 485 Kč

DIN EN 1303

DOM Diamant



Extrémně vysoká ochrana domu, bytu a firemních prostorů



- ✓ nejvyšší kvalita a bezpečnost – ocelová vložka 21 rotujících disků
- ✓ extrémní ochrana proti odvrtávání absolutní nemožnost vytrhnutí jádra
- ✓ nejvyšší technologická ochrana proti kopírování klíče - ocelový 3D klíč s multilinéárním profilem
- ✓ těleso cylindrické vložky vyrobené z vysokokvalitní slitinové ocele (MIM) zaručuje maximální odolnost a ochranu proti odvrtání a vytrhnutí



třída bezpečnosti klíče 6 (STN EN 1303)
třída odolnosti 4 (STN P ENV 1627)
NBÚ „přísně tajné“
odolá dynamické SG metodě („bumping“)

6 313 Kč / 7 639 Kč

DIN EN 1303

DOM SV



Vysoká ochrana domu, bytu a firemních prostorů



- ✓ vysoká kvalita a bezpečnost
- ✓ ochrana proti odvrtání a vytrhnutí jádra
- ✓ vysoká technologická ochrana proti kopírování klíče
- ✓ vložený disk v klíči uvede do pohybu odpružené stavídko

třída bezpečnosti klíče 4 (STN EN 1303)
třída odolnosti 4 (STN P ENV 1627)
NBÚ „přísně tajné“
odolá dynamické SG metodě („bumping“)

1 555 Kč / 1 882 Kč

DIN EN 1303

DOM LS 5



Vysoká ochrana domu, bytu a firemních prostorů



- ✓ vysoká kvalita a bezpečnost
- ✓ ochrana proti odvrtání a vytrhnutí jádra
- ✓ vysoká technologická ochrana proti kopírování klíče

třída bezpečnosti klíče 4 (STN EN 1303)
třída odolnosti 4 (STN P ENV 1627)
NBÚ „přísně tajné“
odolá dynamické SG metodě („bumping“)

1 295 Kč / 1 567 Kč



PRO BEZPEČNĚJŠÍ SVĚT

ISEO

BEZPEČNOST

Bezpečnostní vložky ISEO – 3. bezpečnostní třída (BT 3), odolnost proti nedestruktivní dynamické metodě „SG“ (bumping). Unikátní patent – **odpružená aktivní stavidla**. Registrační karta na výrobu duplikátů originálních klíčů.

KOMFORT

Ochrana proti zlomení klíče při běžném používání, masivní **celokovový** klíč s úpravou pro bezproblémové zasunutí. Sjednocení vložek na **společný uzávěr**, např. dveře v rodinném domě anebo malé firmě.

SPOLEHLIVOST

Prodloužená životnost – test durability na 100 000 cyklů. Vhodné do protipožárních dveří. Výrobce poskytuje rozšířenou záruku 10 let.

SERVIS

Záruční a pozáruční servis, výroba standardních jako i nestandardních vložek na míru do 2 hodin.



ochrana proti odvrtání vložky



dodatečné klíče pouze po předložení bezpečnostní karty



SK: shodný kód umožňuje otevírat dvě anebo více vložek stejným klíčem



vložka dostupná v různých provedení (např. vložka do dveří, skříňková vložka, visací zámek, okenní ...)



vložka je dostupná v uzamykacích systémech



protipožární odolnost

BT 3 bezpečnostní třída 3

záruka 10 záruka 10 let



třída bezpečnosti klíče 6 (STN EN 1303)

ISEO F5



barvy: nikl, mosaz

312 Kč / 378 Kč

ISEO R6

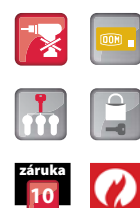

BT 3

barvy: nikl

533 Kč / 645 Kč

ISEO R7

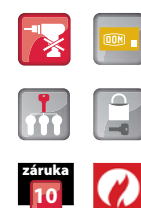

BT 3

barvy: nikl

849 Kč / 1 027 Kč

GERA 3000

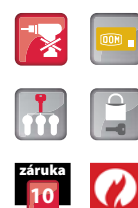

BT 3

barvy: nikl

1 488 Kč / 1 800 Kč

Typy vložek



základní vložka



visací zámek
50/100 mm



oboustranná vložka
s funkcí proti zabouchnutí
(emergency)



visací zámek
50/75 mm



poloviční vložka



visací zámek
60/85 mm



vložka s knoflíkem
z vnitřní strany



celoocelový visací
zámek VHS



vložka s ozubeným věncem



Certifikát - bezpečnostní třída 3
podle STN P ENV 1627 a STN EN 1303



Certifikát NBÚ T10-0003/2011
platný do 21.04.2018



Cena včetně 3 klíčů

| mm | ISEO F5 | | ISEO R6 | |
|-------|---------|-------|---------|-------|
| | Kč | s DPH | Kč | s DPH |
| 30/30 | 296 | 358 | 533 | 645 |
| 30/35 | 312 | 378 | 533 | 645 |
| 30/40 | 338 | 409 | 585 | 708 |
| 30/45 | 364 | 440 | 637 | 771 |
| 30/50 | 398 | 482 | 689 | 834 |
| 30/55 | 437 | 529 | 741 | 897 |
| 30/60 | 481 | 582 | 793 | 960 |
| 30/65 | 528 | 639 | 845 | 1 022 |
| 30/70 | 611 | 739 | 897 | 1 085 |
| 30/75 | 663 | 802 | 949 | 1 148 |
| 30/80 | 741 | 897 | 1 001 | 1 211 |
| 35/35 | 338 | 409 | 585 | 708 |
| 35/40 | 364 | 440 | 637 | 771 |
| 35/45 | 398 | 482 | 689 | 834 |
| 35/50 | 437 | 529 | 741 | 897 |
| 35/55 | 481 | 582 | 793 | 960 |
| 35/65 | 611 | 739 | 897 | 1 085 |
| 40/40 | 378 | 457 | 689 | 834 |
| 40/45 | 437 | 529 | 741 | 897 |
| 40/50 | 481 | 582 | 793 | 960 |
| 40/55 | 528 | 639 | 845 | 1 022 |
| 40/60 | 611 | 739 | 897 | 1 085 |
| 40/70 | - | - | 1 001 | 1 211 |
| 45/45 | 481 | 582 | 793 | 960 |
| 45/50 | 528 | 639 | 845 | 1 022 |
| 45/55 | 598 | 724 | 897 | 1 085 |
| 45/60 | 665 | 805 | 949 | 1 148 |
| 45/65 | 741 | 897 | - | - |
| 50/50 | 610 | 738 | 897 | 1 085 |
| 50/55 | 663 | 802 | 949 | 1 148 |
| 50/60 | 741 | 897 | 1 001 | 1 211 |
| 55/65 | 897 | 1 085 | 1 105 | 1 337 |

| | ISEO F5 | | ISEO R6 | | ISEO R7 | | GERA 3000 | |
|---------------------------------|---------|-------|---------|-------|---------|-------|-----------|-------|
| klíče | Kč | s DPH | Kč | s DPH | Kč | s DPH | Kč | s DPH |
| s vložkou | 22 | 27 | 104 | 126 | 125 | 151 | 130 | 157 |
| dodatečně | 39 | 47 | 172 | 208 | 226 | 273 | 411 | 497 |
| příplatky | | | | | | | | |
| knoflík | 233 | 282 | 233 | 282 | 233 | 282 | 242 | 293 |
| nouzová funkce (emergency) | - | - | 233 | 282 | 233 | 282 | 258 | 312 |
| ozubený věnec | 129 | 156 | 129 | 156 | 129 | 156 | - | - |
| sjednocení vložek | 118 | 143 | 170 | 206 | 170 | 206 | 0,00 | 0,00 |
| visací zámky (2 kl.) | | | | | | | | |
| 50/75 mm | 415 | 502 | | | | | | |
| 50/100 mm | 583 | 705 | | | | | | |
| 60/85 mm | 543 | 657 | | | | | | |
| 70/105 mm | 712 | 862 | | | | | | |
| poloviční vložky (3 kl.) | | | | | | | | |
| 30/10 | 263 | 318 | | | | | | |
| 35/10 | 271 | 328 | | | | | | |
| 40/10 | 279 | 338 | | | | | | |
| 45/10 | 289 | 350 | | | | | | |
| 50/10 | 294 | 356 | | | | | | |
| 55/10 | 307 | 371 | | | | | | |
| 60/10 | 320 | 387 | | | | | | |
| 65/10 | 349 | 422 | | | | | | |
| 70/10 | 377 | 456 | | | | | | |

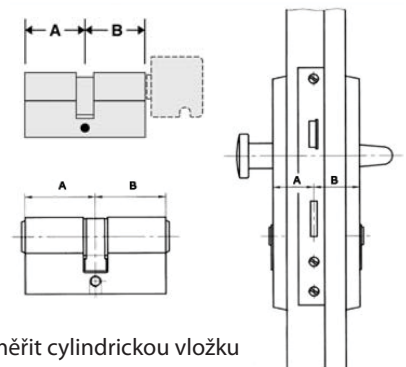

Jak měřit cylindrickou vložku



Všechna úniková kování v souladu se standardem EN 1125:2008 jsou určena na použití v únikových situacích. Mají zabezpečit spolehlivý a bezpečný únik dveřmi s použitím minimální námahy lehkým zatlačením na dveře bez jakékoliv znalosti zařízení na otevírání dveří. Používají se na dveřích únikových východů z veřejných budov (škol, úřadů, kin, divadel, nákupních středisek, sportovních hal, hotelů), které navštěvují vyšší počty lidí.



Proč paniková kování ISEO?

- elegantní moderní design
- ochrana proti zranění
- antibakteriální povrch **zadarmo**
- záruka **10 let**

Trvalá antibakteriální ochrana

Antigerm je antibakteriální povrchová úprava založená na postupném uvolňování iontů stříbra, které pronikají do mikrobů, napadají jejich DNA a zabírají jejich množení. Povrchová úprava Antigerm není pro lidi škodlivá, již v průběhu několika minut je schopná zneškodnit víc jak **650 druhů bakterií** (Salmonella, Legionella, MRSA).

Efekt povrchové úpravy Antigerm je trvalý a nevyžaduje žádnou údržbu. Neustálé uvolňování iontů stříbra zaručuje efektivní působení po celou dobu životnosti produktu, dokonce i v případě poškození povrchu.

Antibakteriální povrchová úprava je **bezplatnou** součástí každého panikového kování ISEO. Takto se zvyšuje Vaše bezpečnost, spolehlivost a celková užitečnost produktu.

Řešení pro každou situaci

panikové kování tlačné



panikové kování dotykové



tlačné kování s integrovaným zámkem



dotykové kování s integrovaným zámkem



panikové kování Pad



panikové kování na sklo



akustická signalizace



Bolt - západka proti vylovení, přefezání



panikové zámky



řešení na požární uzávěry



inox PVD do agresivního prostředí





Řešení pro každou situaci najdete v katalogu **Paniková kování** na www.ap-metalia.cz

Další výhody

- elegantní moderní design – oblé tvary chrání před zraněním
- nízká uvolňovací síla
- velmi vysoká odolnost proti korozi 240h (prEN1670)
- dlouhá životnost – test durability > 200.000 cyklů
- lehká montáž bez zásahu do dveřního křídla

Montáž na:

- jednokřídlové i dvoukřídlové dveře
- všeobecné i protipožární dveře
- dveře z úzkých profilů – šířka konzoly 37 mm
- montážní deska zaručí pevné ukotvení na konstrukci dveří v případě vysoké frekvence používání

Base 1-KŘÍDLOVÉ DVEŘE - UZAMKNUTÍ 1-BODOVÉ



2 univerzální konzoly – pravolevé vyhotovení
příprava na 2- a 3-bodové uzamknutí
ocelová samozápadka s bezpečnostní pojistkou
vodorovné madlo (možná úprava na užší dveře)

záruka 10 let
antibakteriální povrch **zadarmo**
povrchy: červeno-černé, šedé

| | | | | | | | | | |
|---|---|---|---|---|---|---|---|---|---|
| 3 | 7 | 6 | B | 1 | 4 | 2 | 2 | A | A |
|---|---|---|---|---|---|---|---|---|---|

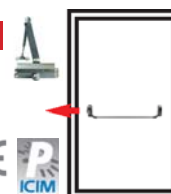
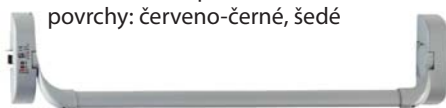

| šířka křídla | | | |
|--------------|-------|--------------|-------|
| 1300 mm | | 1500 mm | |
| bez DPH | s DPH | bez DPH | s DPH |
| 3 328 | 4 027 | 3 718 | 4 499 |

Base 1-KŘÍDLOVÉ DVEŘE - UZAMKNUTÍ 2-BODOVÉ



2 univerzální konzoly - pravolevé vyhotovení
vodorovné madlo (možná úprava na užší dveře)
zámkové moduly HD (horní+dolní)
ocelové samozápadky s bezpečnostní pojistkou
svíslé rozvory + kovové kryty 2400 mm (3400 mm)

záruka 10 let
antibakteriální povrch **zadarmo**
povrchy: červeno-černé, šedé



1-KŘÍDLOVÉ DVEŘE - UZAMKNUTÍ 3-BODOVÉ

2 univerzální konzoly - pravolevé vyhotovení
vodorovné madlo (možná úprava na užší dveře)
zámkové moduly HD (horní+dolní)
ocelové samozápadky s bezpečnostní pojistkou
svíslé rozvory + kovové západky 2400 mm (3400 mm)

záruka 10 let
antibakteriální povrch **zadarmo**
povrchy: červeno-černé, šedé

| | | | | | | | | | |
|---|---|---|---|---|---|---|---|---|---|
| 3 | 7 | 6 | B | 1 | 4 | 2 | 2 | A | A |
|---|---|---|---|---|---|---|---|---|---|

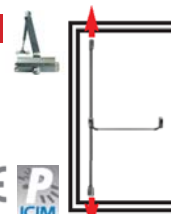

| dveřní křídlo | šířka | | | |
|---------------|--------------|-------|--------------|-------|
| | 1300 mm | | 1500 mm | |
| výška | bez DPH | s DPH | bez DPH | s DPH |
| 2270 mm | 5 668 | 6 858 | 6 058 | 7 330 |
| 3400 mm | 6 188 | 7 487 | 6 578 | 7 959 |

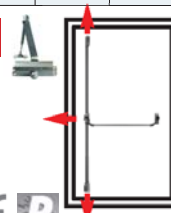

| dveřní křídlo | šířka | | | |
|---------------|--------------|-------|--------------|-------|
| | 1300 mm | | 1500 mm | |
| výška | bez DPH | s DPH | bez DPH | s DPH |
| 2270 mm | 6 292 | 7 613 | 6 682 | 8 085 |
| 3400 mm | 6 812 | 8 243 | 7 202 | 8 714 |

Base 2-KŘÍDLOVÉ DVEŘE - aktivní křídlo + pasivní křídlo

Aktivní křídlo se otevírá jako první a zavírá jako poslední

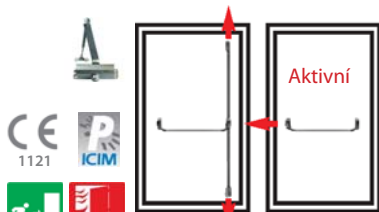

Base 2K-B/HD

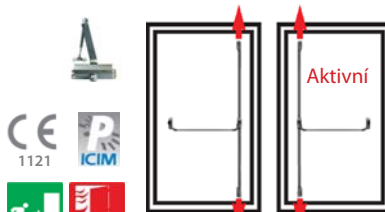

Base 2K-HD/HD

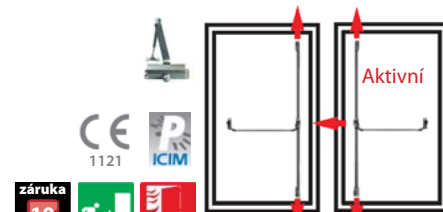

Base 2K-BHD/HD

| dveřní křídlo | šířka | | | |
|---------------|---------------|--------|---------------|--------|
| | 1300 mm | | 1500 mm | |
| výška | bez DPH | s DPH | bez DPH | s DPH |
| 2270 mm | 9 828 | 11 892 | 10 556 | 12 773 |
| 3400 mm | 10 348 | 12 521 | 11 128 | 13 465 |

| dveřní křídlo | šířka | | | |
|---------------|---------------|--------|---------------|--------|
| | 1300 mm | | 1500 mm | |
| výška | bez DPH | s DPH | bez DPH | s DPH |
| 2270 mm | 12 922 | 15 636 | 13 234 | 16 013 |
| 3400 mm | 13 546 | 16 391 | 13 832 | 16 737 |

| dveřní křídlo | šířka | | | |
|---------------|---------------|--------|---------------|--------|
| | 1300 mm | | 1500 mm | |
| výška | bez DPH | s DPH | bez DPH | s DPH |
| 2270 mm | 13 702 | 16 579 | 14 014 | 16 957 |
| 3400 mm | 14 326 | 17 334 | 14 612 | 17 681 |

Potřebujete řešení s panikovým zámkem a s klikami?



Tessa D M15
panikový zámek

Kč Kč s DPH

| | |
|-----|-------|
| 597 | 722 |
| 857 | 1 037 |





klika k panikovému kování

| | | |
|-------|--------------|-------|
| | bez DPH | s DPH |
| klika | 1 711 | 2 070 |



knoflík k panikovému kování

| | | |
|---------|--------------|-------|
| | bez DPH | s DPH |
| knoflík | 1 451 | 1 756 |
| vložka | 263 | 318 |

kování na sklo

OVAL F1 (alu)

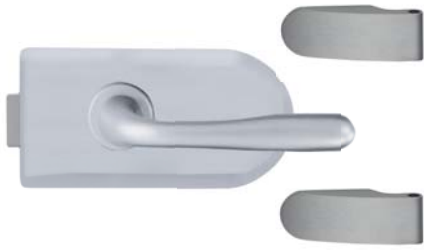

| | Kč | Kč s DPH |
|----------|-------|----------|
| s klikou | 3 614 | 4 373 |
| BB, PZ | 3 614 | 4 373 |
| WC | 4 264 | 5 159 |
| protikus | 1 170 | 1 416 |

OVAL M15 (nerez)

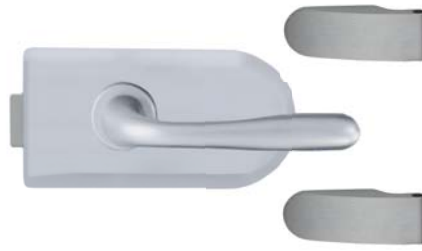

| | Kč | Kč s DPH |
|----------|-------|----------|
| s klikou | 5 148 | 6 229 |
| BB, PZ | 5 148 | 6 229 |
| WC | 5 798 | 7 016 |
| protikus | 1 170 | 1 416 |

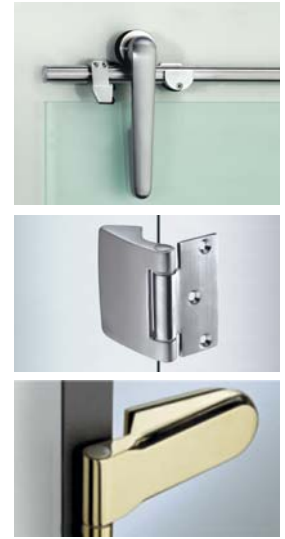

OVAL M1 / M2 / M4 / M9 / M18

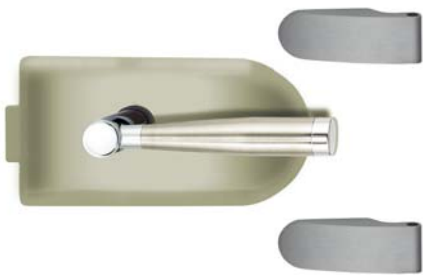

| | Kč | Kč s DPH |
|----------|-------|----------|
| s klikou | 6 474 | 7 834 |
| BB, PZ | 6 474 | 7 834 |
| WC | 6 734 | 8 148 |
| protikus | 2 340 | 2 831 |

FERRARI M1 / M2 / M4 / M9 / M18



| | Kč | Kč s DPH |
|----------|-------|----------|
| s klikou | 7 150 | 8 652 |
| BB, PZ | 7 150 | 8 652 |
| WC | 7 540 | 9 123 |
| protikus | 3 250 | 3 933 |



STAR MADÉLKO (pár)



Ø 40 mm

ARTITEC
DESIGN TECHNOLOGY



M15

matný
lesklý

| | Kč | Kč s DPH |
|--------|-----|----------|
| matný | 761 | 921 |
| lesklý | 878 | 1 062 |

SUN MADÉLKO (pár)



Ø 40 mm

ARTITEC
DESIGN TECHNOLOGY



M15

matný
lesklý

| | Kč | Kč s DPH |
|--------|-----|----------|
| matný | 732 | 886 |
| lesklý | 848 | 1 026 |

PHOENIX MADÉLKO (pár)



38 x 38 mm

Kč Kč s DPH

M15

matný
lesklý

| | | |
|--------|-------|-------|
| matný | 1 024 | 1 239 |
| lesklý | 1 156 | 1 399 |



ENTRO 50 MADÉLKO (ks)



Ø 50 mm

M15

matný

| | Kč | Kč s DPH |
|-------|-----|----------|
| matný | 527 | 638 |



3D nastavitelné panty ø 14, 16, 20 mm

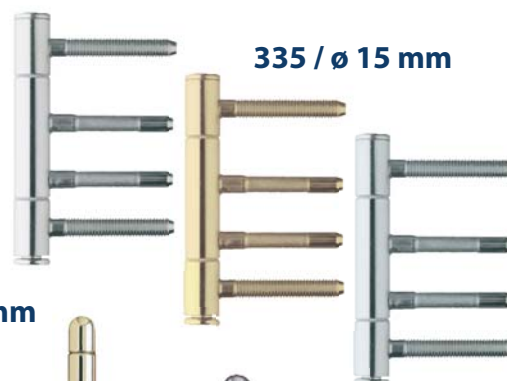

335 / ø 15 mm

3D nastavitelné panty ø 18 mm

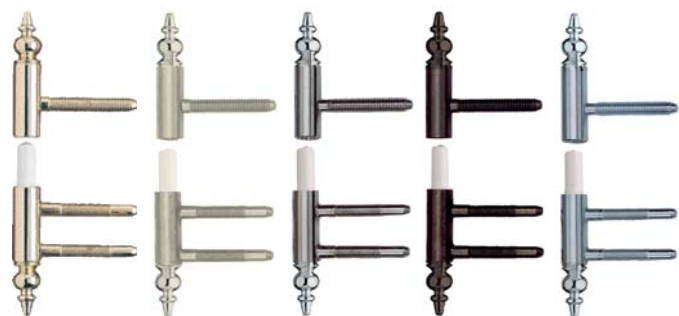

221 / ø 15 mm

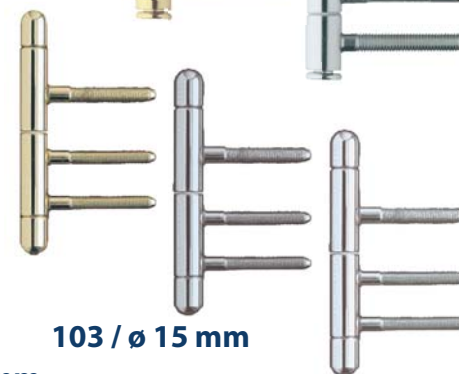

103 / ø 15 mm

panty 101 / ø 15 mm

panty 100 / ø 15 mm



www.panty.sk

Naleznete:
- technickou specifikaci
- rozměry
- ceny

samozatvírače Telesco s tlumeným zavíráním – povrch stříbrný



EXPERT 3605F (EN 5)
na dveře max 110 cm 80 kg



EXPERT 3606F (EN 6)
na dveře max 125 cm 100 kg



EXPERT Flexi (EN 2 - 4)
na dveře max 140 cm 120 kg

| | Kč | Kč s DPH |
|--------------|-------|----------|
| Expert 3605F | 3 295 | 3 987 |

| | Kč | Kč s DPH |
|--------------|-------|----------|
| Flexi F3606F | 3 510 | 4 247 |

| | Kč | Kč s DPH |
|--------------|-------|----------|
| Flexi F3659F | 3 717 | 4 498 |

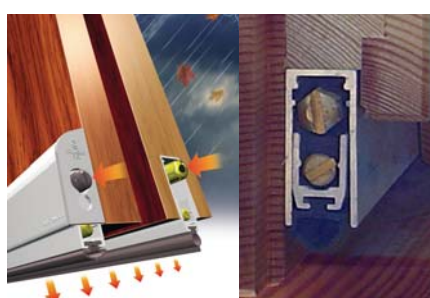
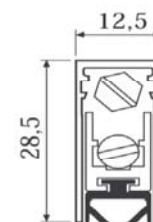
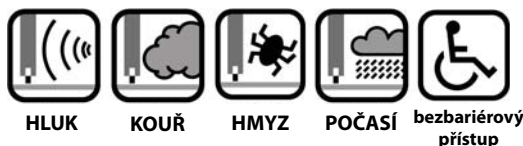

padací prahové lišty

| do drážky | Kč | Kč s DPH |
|-----------|-----|----------|
| 63 cm | 398 | 482 |
| 73 cm | 403 | 488 |
| 83 cm | 411 | 497 |
| 93 cm | 422 | 511 |
| 103 cm | 433 | 524 |
| 113 cm | 451 | 546 |



padací prahové lišty

| externí | Kč | Kč s DPH |
|---------|-----|----------|
| 63 cm | 597 | 722 |
| 73 cm | 600 | 726 |
| 83 cm | 613 | 742 |
| 93 cm | 623 | 754 |
| 103 cm | 634 | 767 |
| 113 cm | 650 | 787 |

koule antikorozi (ks)

Entro 96100



Kč Kč s DPH
527 638

Mira M4/M9



Kč Kč s DPH
494 598

Ferrara S M15



Kč Kč s DPH
467 565

Palermo S M15



Kč Kč s DPH
519 628

Ferrara M15



Kč Kč s DPH
441 534

Palermo M15



Kč Kč s DPH
441 534

mušle na posuvné dveře (ks)

mušle 01022 M15



| | Kč | Kč s DPH |
|----------|-----|----------|
| ø 40 mm | 101 | 122 |
| ø 50 mm | 124 | 150 |
| ø 70 mm | 161 | 195 |
| ø 110 mm | 285 | 345 |

mušle 01023 M15



| | Kč | Kč s DPH |
|-------|-----|----------|
| 50x50 | 141 | 171 |
| 70x70 | 216 | 261 |

mušle 01024 M15



asymetrická

| | Kč | Kč s DPH |
|---------|-----|----------|
| 70x70 | 216 | 261 |
| 110x110 | 399 | 483 |

mušle Piccolo M15



Kč Kč s DPH
188 227



antikorozi ocel
AISI 304



ø 50 mm
ø 75 mm



piktogramy

Kč Kč s DPH
299 362



výška 120 mm

| | Kč | Kč s DPH |
|----------|-----|----------|
| čísllice | 165 | 200 |
| písmena | 165 | 200 |

dveřní zarážky

1997



25 / ø 25 mm

Kč Kč s DPH

| | | |
|-------------|-----|-----|
| 1997 | 114 | 138 |
| 2004 | 142 | 172 |
| 2001 | 273 | 330 |
| 2034 | 208 | 252 |

2004



40 / ø 30 mm

2001



52 / ø 32 mm

2034 stěnová



48 / ø 25 mm

2032 volně stojící



40 / ø 90 mm

Kč Kč s DPH

| | | |
|-------------|-----|-----|
| 2032 | 359 | 434 |
| 2038 | 699 | 846 |
| 2039 | 550 | 666 |

2039



Robust 2038 s aretací na těžké dveře

koule mosazné (ks)



| | Kč | Kč s DPH |
|-------------|-----|----------|
| M1, M2, M3 | 337 | 408 |
| M4, M9, M18 | 363 | 439 |

klepadlo Lev



| | Kč | Kč s DPH |
|------------|-----|----------|
| M1, M2, M3 | 458 | 554 |

klepadlo Impero



| | Kč | Kč s DPH |
|------------------------------|-----|----------|
| M1, M2, M3, MC3, M4, M9, M18 | 411 | 497 |

**Victorian
vhoz na dopisy**



| | Kč | Kč s DPH |
|------------|-----|----------|
| M1, M3, M9 | 615 | 744 |

mušle na posuvné dveře (ks)

mušle Malaga



| | Kč | Kč s DPH |
|-------------|-----|----------|
| M1, M2, M3 | 302 | 365 |
| M4, M9, M18 | 363 | 439 |

mušle Arezia M1



| | Kč | Kč s DPH |
|--|-----|----------|
| | 260 | 315 |

mušle Piccolo



| | Kč | Kč s DPH |
|---------|-----|----------|
| M1, M3 | 154 | 186 |
| M4, M18 | 206 | 249 |

mušle 30 mm



| | Kč | Kč s DPH |
|--------|----|----------|
| M2, M3 | 77 | 93 |
| M9 | 99 | 120 |

mušle se zámkem WC (komplet)



| | Kč | Kč s DPH |
|-------------|-----|----------|
| M1, M2, M3 | 518 | 627 |
| M4, M9, M18 | 589 | 713 |

dveřní zarážky

dveřní zarážka 405



| | Kč | Kč s DPH |
|-------------|-----|----------|
| M1, M2, M3 | 77 | 93 |
| M4, M9, M18 | 103 | 125 |
| M0 | 129 | 156 |

dveřní zarážka 407



| | Kč | Kč s DPH |
|-------------|-----|----------|
| M1, M2, M3 | 189 | 229 |
| M4, M9, M50 | 285 | 345 |

dveřní zarážka 430



| | Kč | Kč s DPH |
|-------------|-----|----------|
| M1, M9, M50 | 494 | 598 |

koule ALU (ks)



| | Kč | Kč s DPH |
|------------|-----|----------|
| F1, F2, F4 | 181 | 219 |
| F9 | 207 | 250 |

madélko na dveře



| | Kč | Kč s DPH |
|------------|----|----------|
| F1, F4, F9 | 60 | 73 |

mušle Lucy



| | Kč | Kč s DPH |
|--------|----|----------|
| F1, F4 | 58 | 70 |
| F9 | 63 | 76 |

mušle Ema



| | Kč | Kč s DPH |
|--------|-----|----------|
| F1, F4 | 128 | 155 |
| F9 | 180 | 218 |

ALU Ferrara S (ks)



| | Kč | Kč s DPH |
|----|-----|----------|
| F1 | 247 | 299 |
| F9 | 284 | 344 |



40-stránkový katalog nerezových stavebních kování včetně objektových a protipožárních kování



přehledný průvodce panikovým řešením tak i bližší informace o nové antibakteriální povrchové úpravě a 10-ti leté záruce



20-stránkový katalog hliníkových bezpečnostních kování Dieckmann a interiérových kování



všechny potřebné informace o uzamknutí Vašeho bytu, domu či kanceláře



kování na dveře a okna z profilů, cylindrické a bezpečnostní vložky a protipožární kování ve 4. třídě zatížení



Metalia Architekt Partner s.r.o.
Reneská třída 12
639 00 Brno - Štýřice

tel.: +420 542 212 568
fax: +420 545 215 983

mobil:
+420 723 642 952
+420 723 137 256

www.ap-metalia.cz
www.kovani-dvere.cz